



Rettungsdatenblätter



Rechtlicher Hinweis:

Diese Rettungsdatenblätter wurden ausschließlich für Rettungskräfte erstellt, die über spezielle Ausbildung auf dem Gebiet der technischen Hilfeleistung nach Verkehrsunfällen verfügen.

Diese Rettungsdatenblätter enthalten ausschließlich Informationen über Fahrzeuge, die zum Verkauf in der Europäischen Union bestimmt sind.

Spezifikationen und Sonderausstattungen der Ford Fahrzeuge sowie das Fahrzeugangebot der Ford Werke GmbH unterliegen etwaigen Änderungen.

Daher behält sich die Ford Werke GmbH inhaltliche Anpassungen bzw. Änderungen an diesen Rettungsdatenblättern jederzeit ausdrücklich vor.

Die vorliegenden Unterlagen wurden mit der größtmöglichen Sorgfalt erstellt, für fehlende oder falsche Angaben kann jedoch keine Haftung übernommen werden.

Für nachträglich durchgeführte Veränderungen am Fahrzeug kann ebenfalls keine Haftung übernommen werden.

Beachten Sie bitte: Die in diesen Rettungsdatenblättern enthaltenen Informationen sind nicht für Endkunden und ebenfalls nicht für Werkstätten und Händler bestimmt.

(Stand: 12/2009)



Modellbezeichnung

Baujahr

Modellbezeichnung

Baujahr

C

- C-MAX 06/2003 - 10/2007
- C-MAX (CNG) 06/2003 - 10/2007
- C-MAX (LPG) 06/2003 - 10/2007
- C-MAX 10/2007 ->
- C-MAX (CNG) 10/2007 ->
- C-MAX (LPG) 10/2007 ->

F

- | | | | |
|-------------------------|-------------------|-----------------------|------------|
| • Fiesta | 08/1995 - 02/2000 | • Focus (3 Türer) | 08/2007 -> |
| • Fiesta | 02/2000 - 02/2002 | • Focus (3 Türer CNG) | 08/2007 -> |
| • Fiesta (3 Türer) | 11/2001 - 09/2008 | • Focus (3 Türer LPG) | 08/2007 -> |
| • Fiesta (5 Türer) | 11/2001 - 09/2008 | • Focus (4 Türer) | 08/2007 -> |
| • Fiesta (3 Türer) | 06/2008 -> | • Focus (5 Türer) | 08/2007 -> |
| • Fiesta (3 Türer LPG) | 06/2008 -> | • Focus (5 Türer CNG) | 08/2007 -> |
| • Fiesta (5 Türer) | 06/2008 -> | • Focus (5 Türer LPG) | 08/2007 -> |
| • Fiesta (5 Türer LPG) | 06/2008 -> | • Focus (Turnier) | 08/2007 -> |
| • Focus (3 Türer) | 08/1999 - 12/2004 | • Focus (Turnier LPG) | 08/2007 -> |
| • Focus (4 Türer) | 08/1999 - 12/2004 | • Fusion | 06/2002 -> |
| • Focus (5 Türer) | 08/1999 - 12/2004 | | |
| • Focus (Turnier) | 08/1999 - 12/2004 | | |
| • Focus Coupé Cabriolet | 06/2004 -> | | |
| • Focus (3 Türer) | 07/2004 - 08/2007 | | |
| • Focus (3 Türer CNG) | 07/2004 - 08/2007 | | |
| • Focus (3 Türer LPG) | 07/2004 - 08/2007 | | |
| • Focus (4 Türer) | 07/2004 - 08/2007 | | |
| • Focus (5 Türer) | 07/2004 - 08/2007 | | |
| • Focus (5 Türer CNG) | 07/2004 - 08/2007 | | |
| • Focus (5 Türer LPG) | 07/2004 - 08/2007 | | |
| • Focus (Turnier) | 07/2004 - 08/2007 | | |
| • Focus (Turnier LPG) | 07/2004 - 08/2007 | | |

**Modellbezeichnung****Baujahr****G**

- Galaxy 04/2000 - 02/2006
- Galaxy 02/2006 ->

K

- KA 09/1996 - 07/2008
- Ka 08/2008 ->
- Kuga 02/2008 ->

M

- Mondeo (4 Tüer) 10/2000 - 02/2007
- Mondeo (5 Tüer) 10/2000 - 02/2007
- Mondeo (Turnier) 10/2000 - 02/2007
- Mondeo (4 Tüer) 02/2007 ->
- Mondeo (4Tüer LPG) 02/2007 ->
- Mondeo (5 Tüer) 02/2007 ->
- Mondeo (5 Tüer LPG) 02/2007 ->
- Mondeo (Turnier) 02/2007 ->
- Mondeo (Turnier LPG) 08/2007 ->

S

- S-MAX 02/2006 ->



Ford C-MAX

06/2003-10/2007

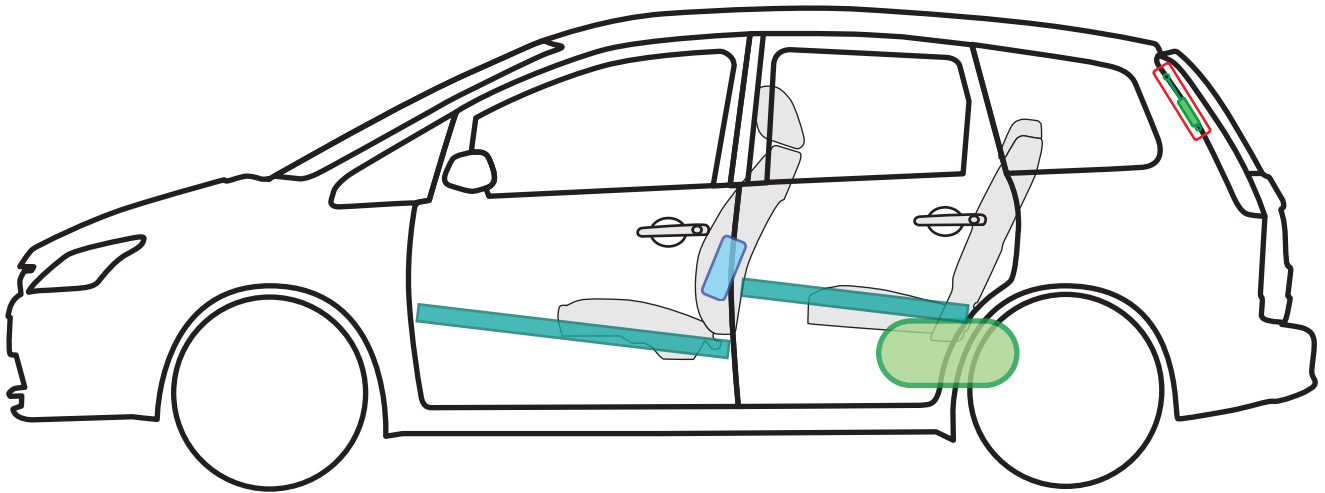
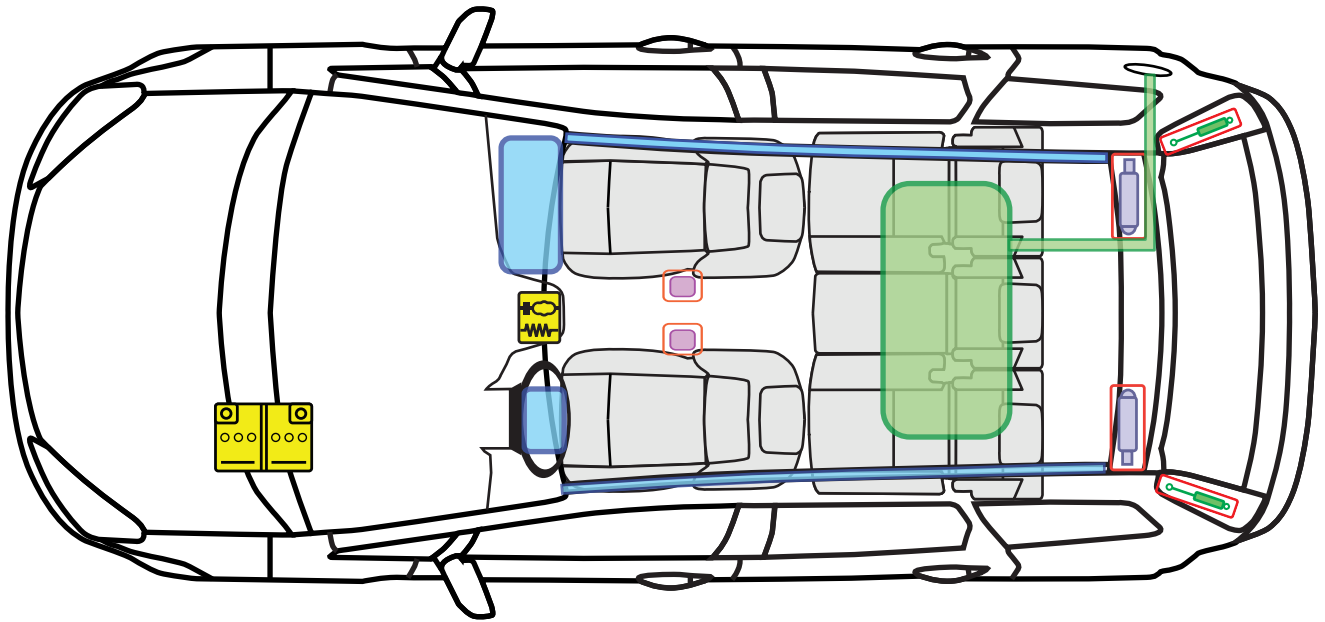

Legende

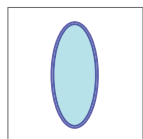

Airbag

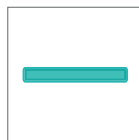

Karosserie-
verstärkung



Steuergerät



Gas-
generator

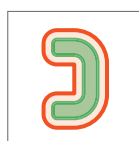

Überroll-
schutz

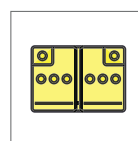

Batterie

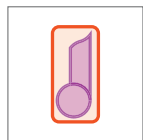

Gurt-
straffer



Gasdruck-
dämpfer

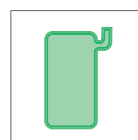

Kraftstoff-
tank





Ford C-MAX

06/2003-10/2007

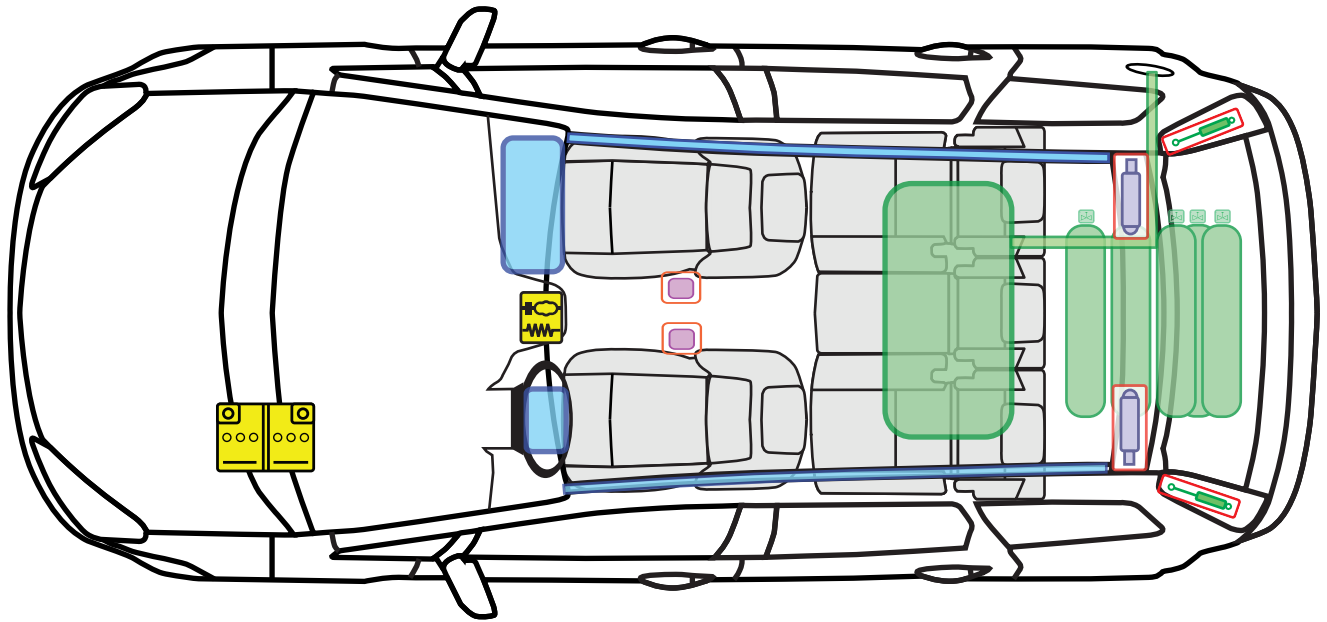

CNG

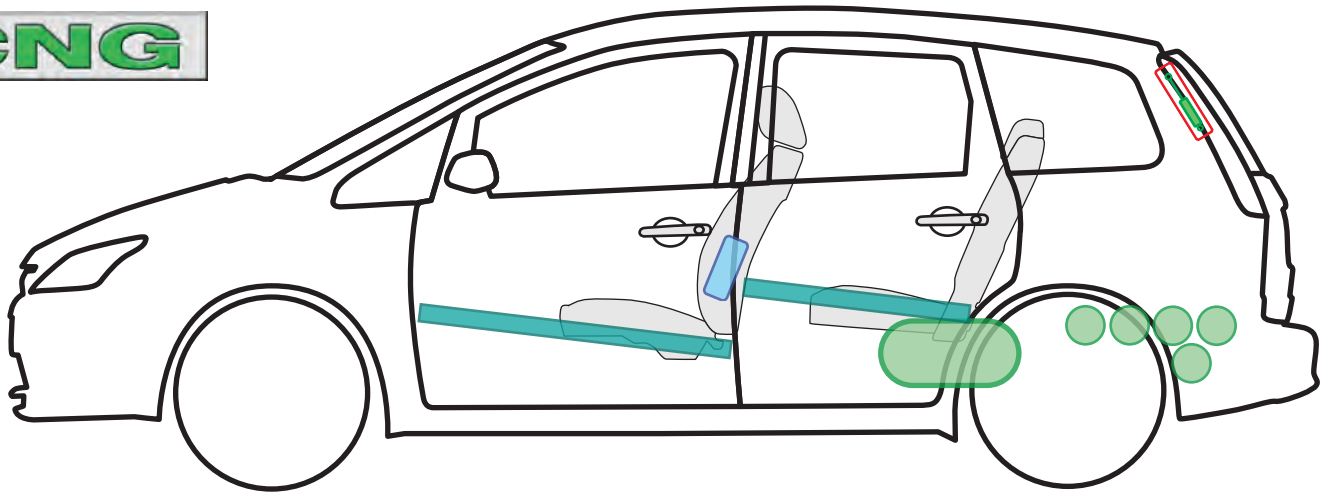

Legende

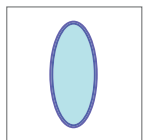

Airbag

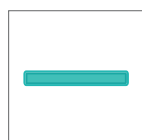

Karosserie-
verstärkung



Steuergerät



Gas-
generator



Überroll-
schutz

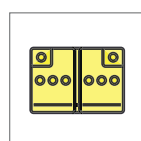

Batterie

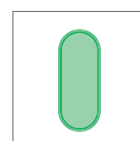

Gastank

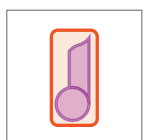

Gurt-
straffer



Gasdruck-
dämpfer

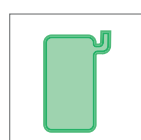

Kraftstoff-
tank

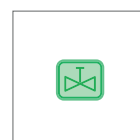

Sicherheits-
ventil





Ford C-MAX

06/2003-10/2007

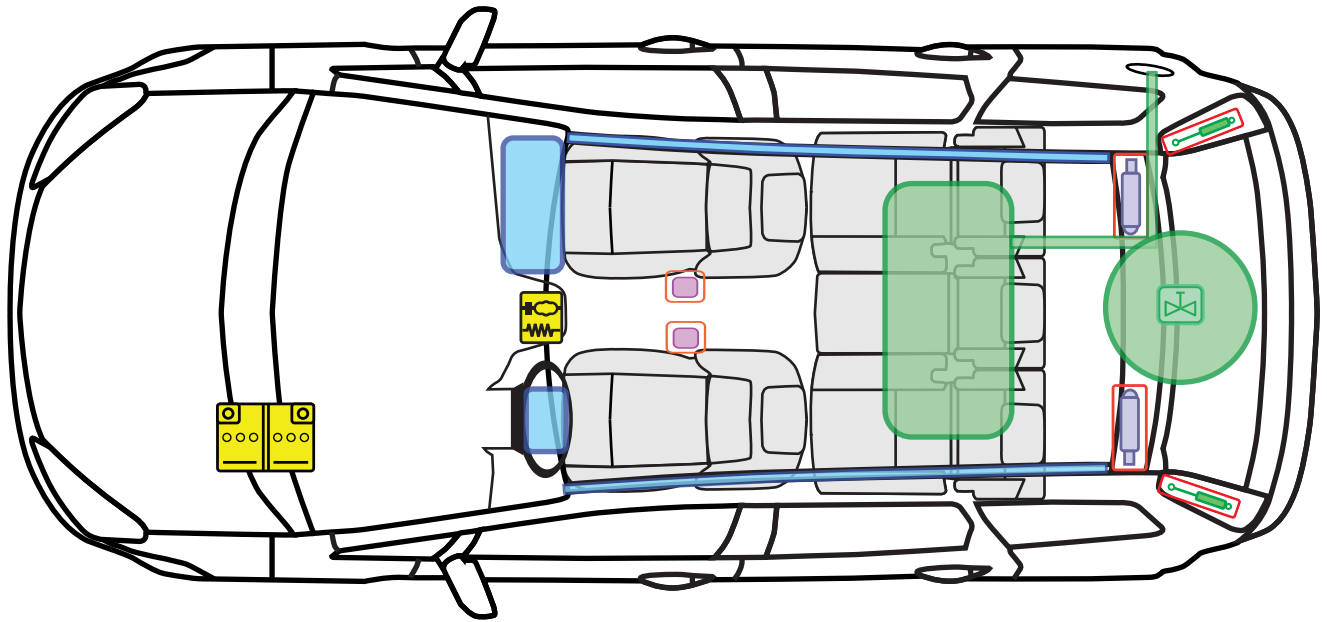

LPG

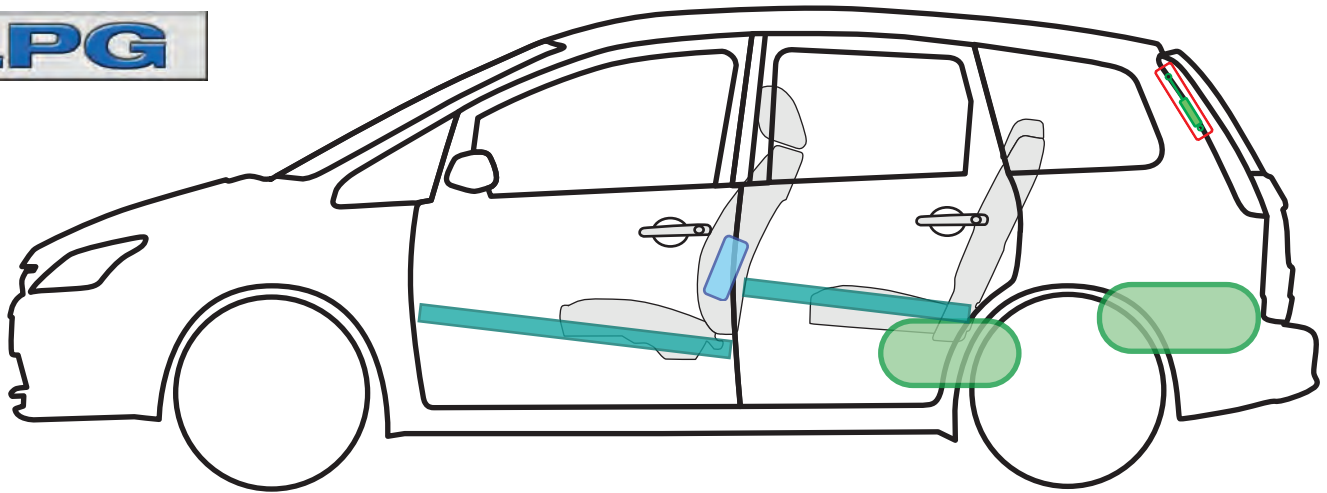

Legende

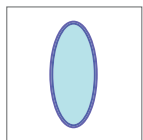

Airbag

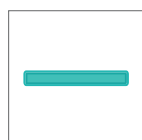

Karosserie-
verstärkung



Steuergerät

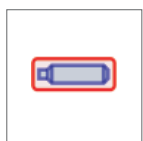

Gas-
generator



Überroll-
schutz

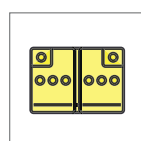

Batterie

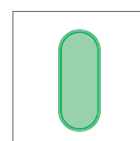

Gastank

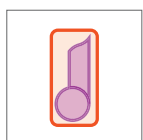

Gurt-
straffer



Gasdruck-
dämpfer

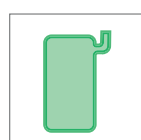

Kraftstoff-
tank

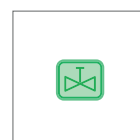

Sicherheits-
ventil





Ford C-MAX

10/2007->

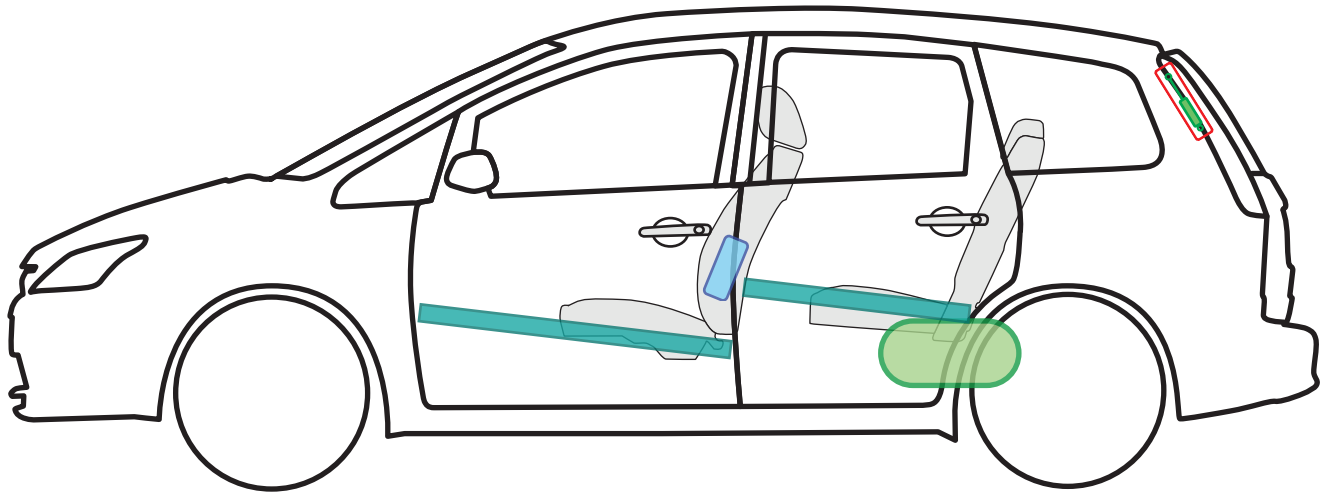
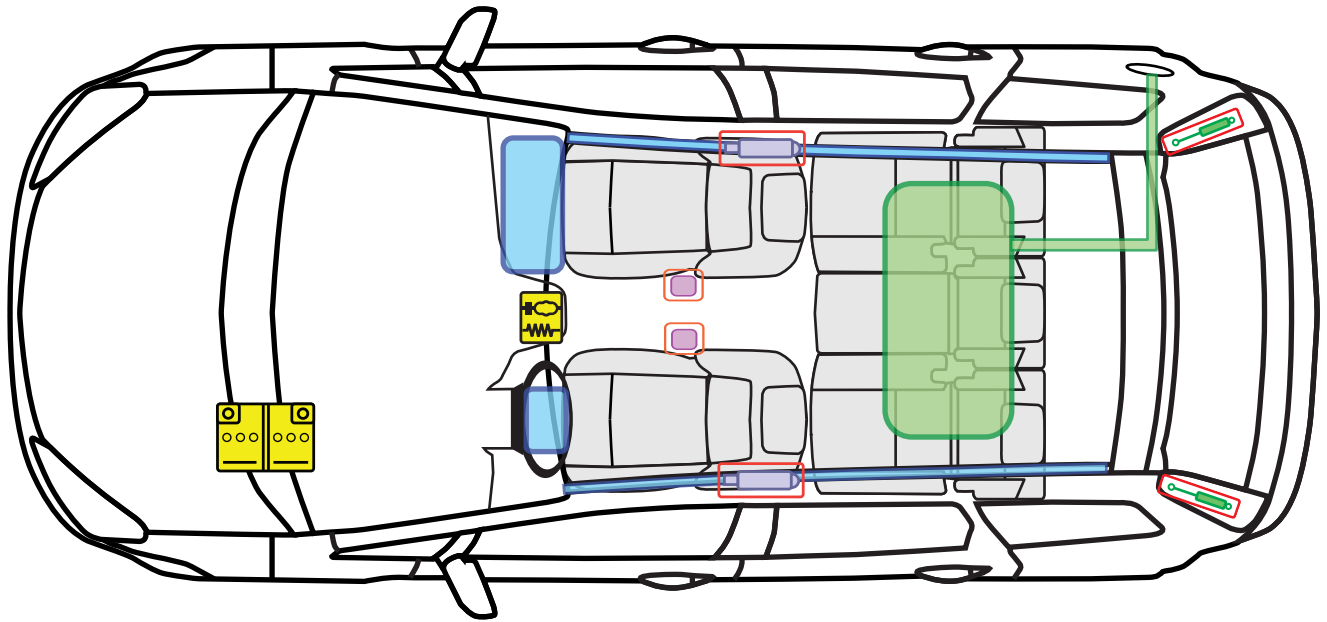

Legende

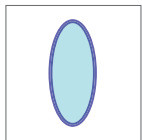

Airbag

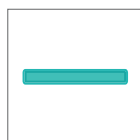

Karosserie-
verstärkung



Steuergerät



Gas-
generator



Überroll-
schutz

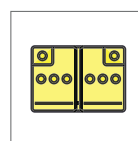

Batterie

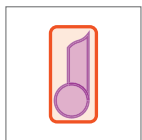

Gurt-
straffer

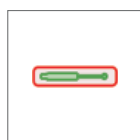

Gasdruck-
dämpfer

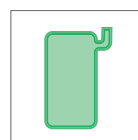

Kraftstoff-
tank





Ford C-MAX

10/2007->

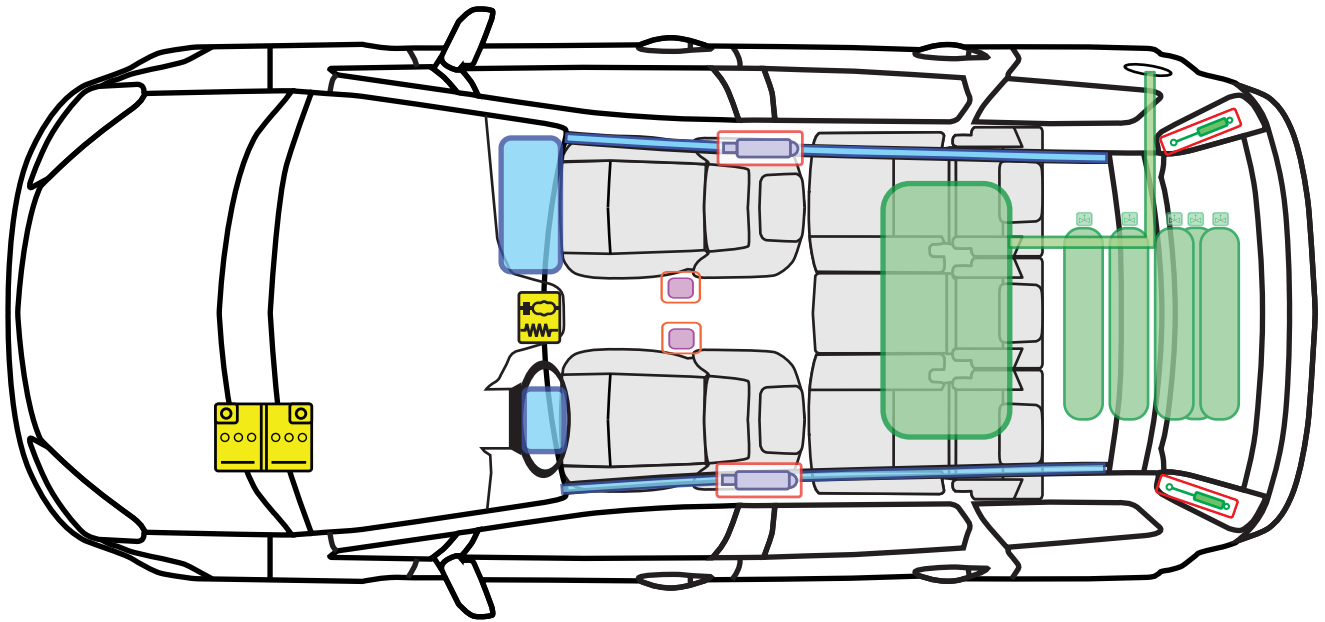

CNG

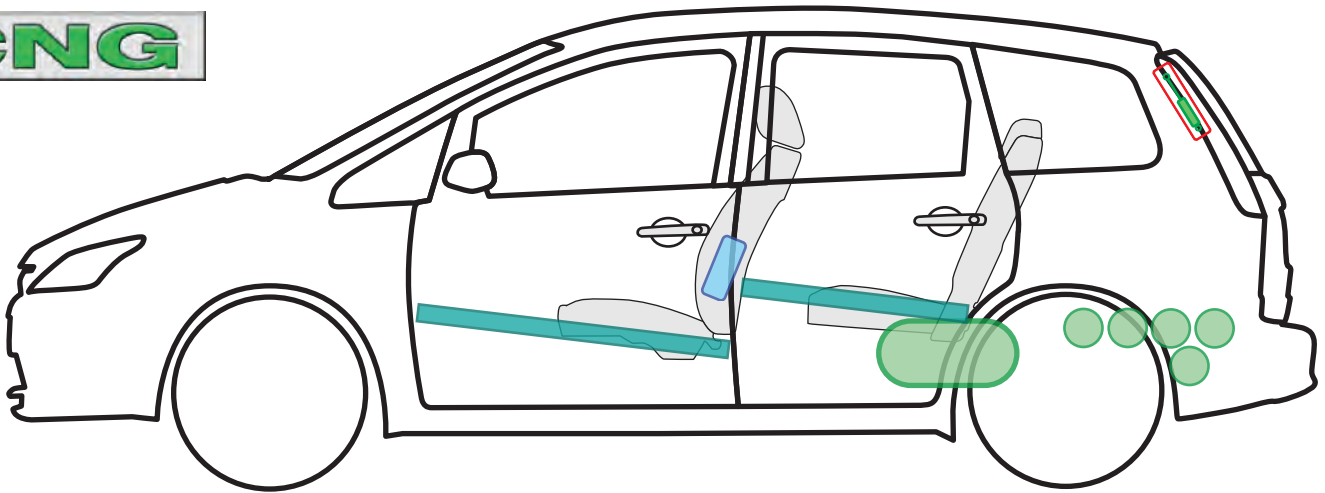

Legende

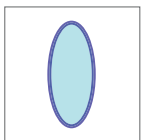

Airbag

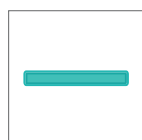

Karosserie-verstärkung



Steuergerät



Gas-generator



Überroll-schutz

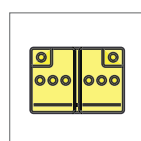

Batterie

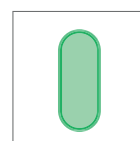

Gastank

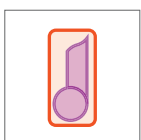

Gurt-straffer



Gasdruck-dämpfer

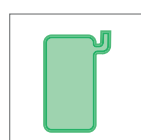

Kraftstoff-tank

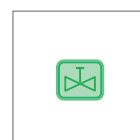

Sicherheits-ventil

C



Ford C-MAX

10/2007->

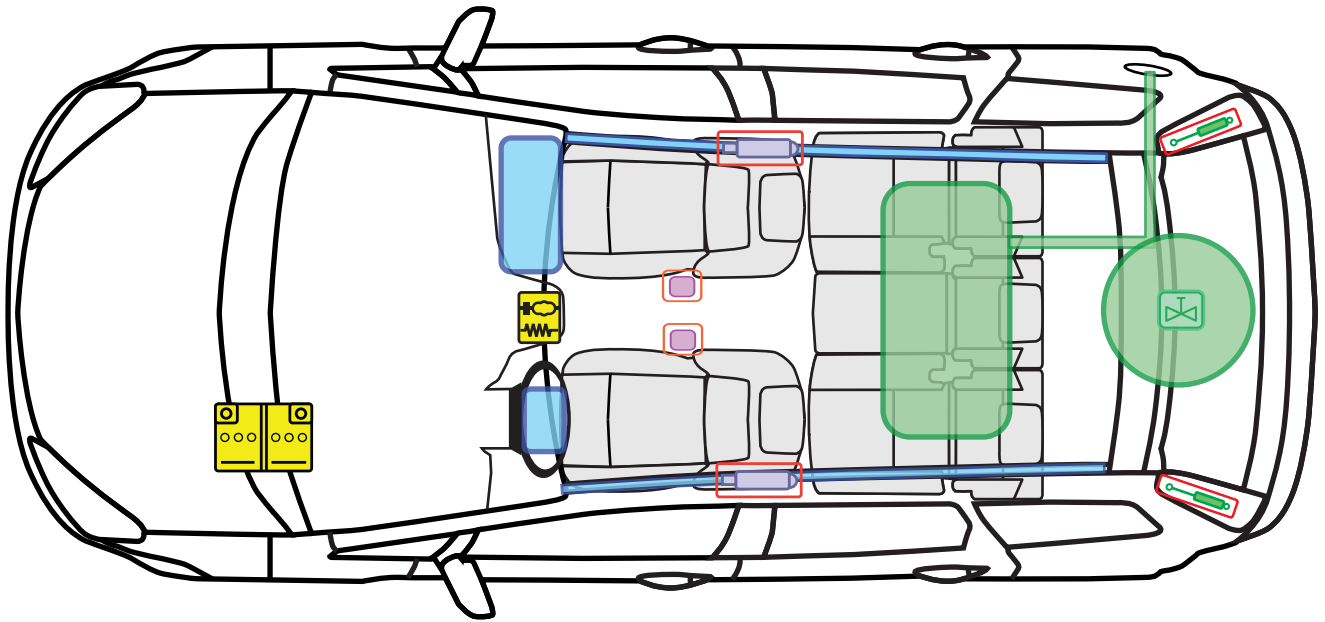

LPG

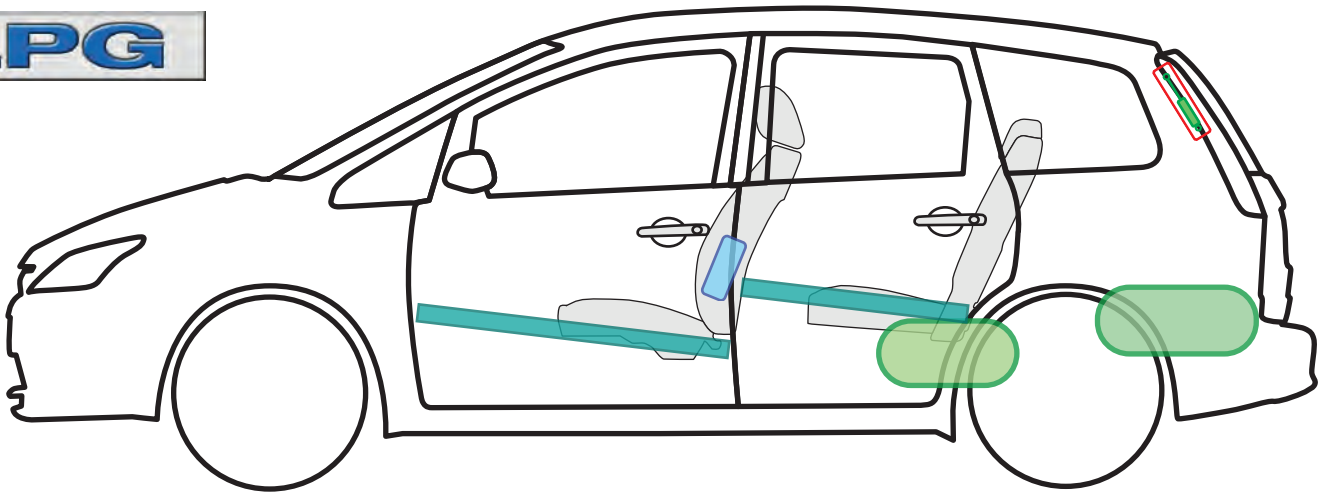

Legende

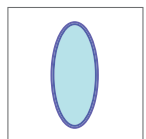

Airbag

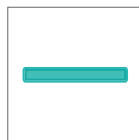

Karosserie-
verstärkung



Steuergerät



Gas-
generator

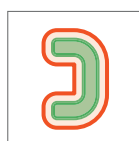

Überroll-
schutz

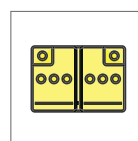

Batterie

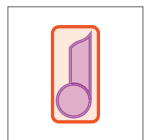

Gurt-
straffer

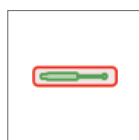

Gasdruck-
dämpfer

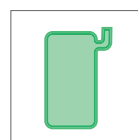

Kraftstoff-
tank





Ford Fiesta

08/1995 - 02/2000

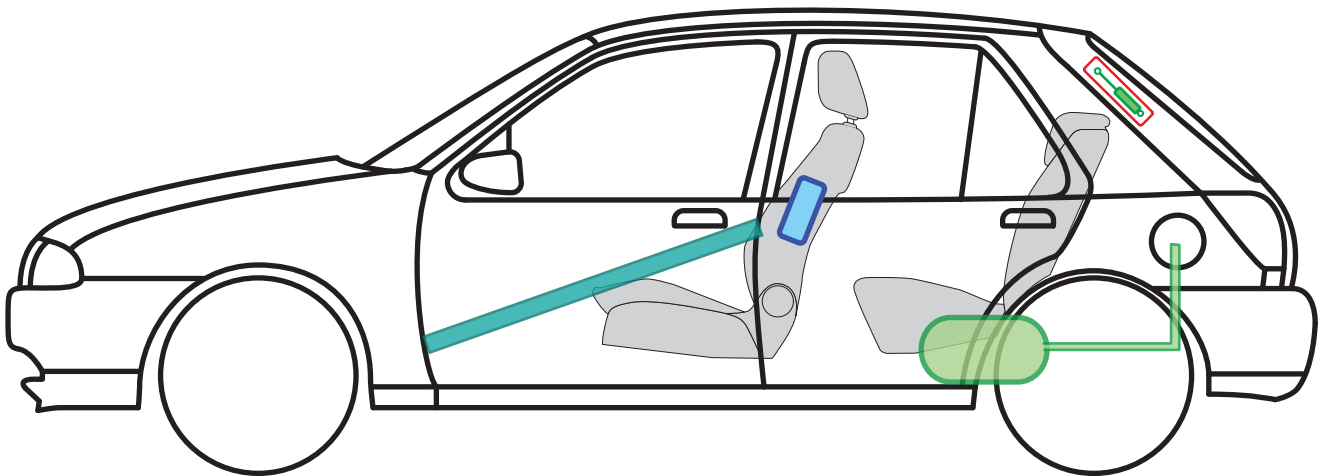
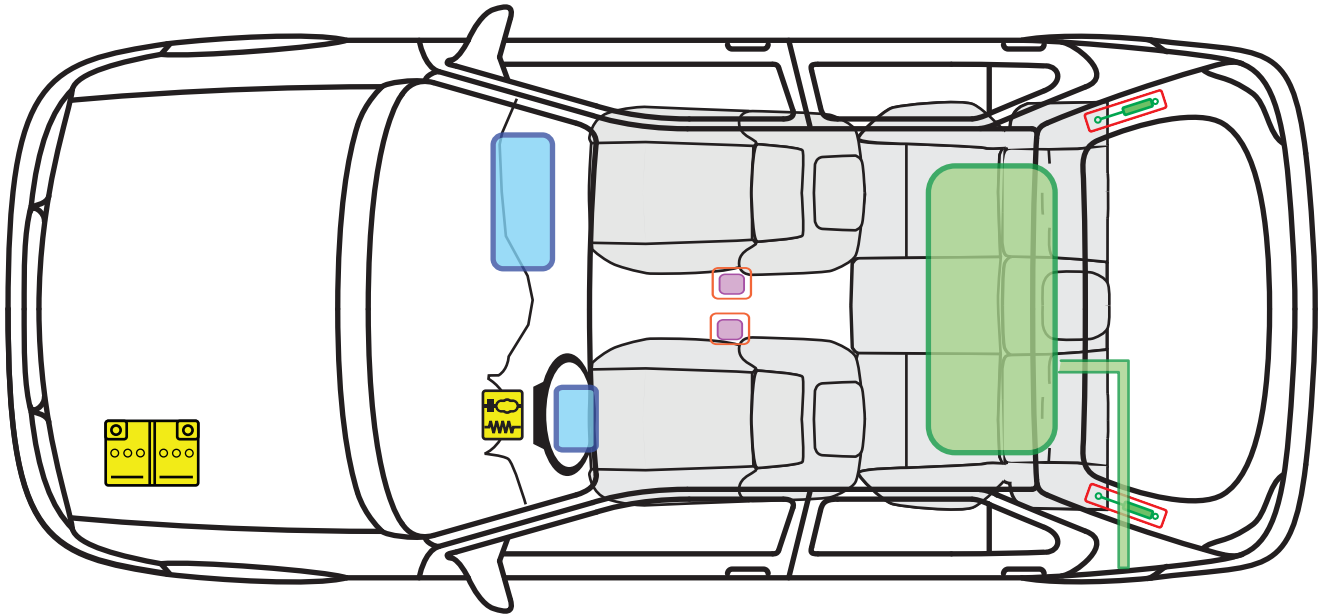

Legende

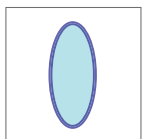

Airbag

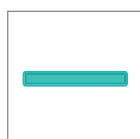

Karosserie-
verstärkung



Steuergerät



Gas-
generator



Überroll-
schutz

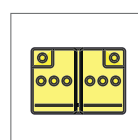

Batterie

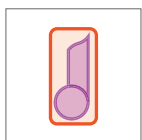

Gurt-
straffer



Gasdruck-
dämpfer

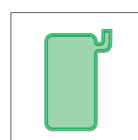

Kraftstoff-
tank

F



Ford Fiesta

02/2000 - 02/2002

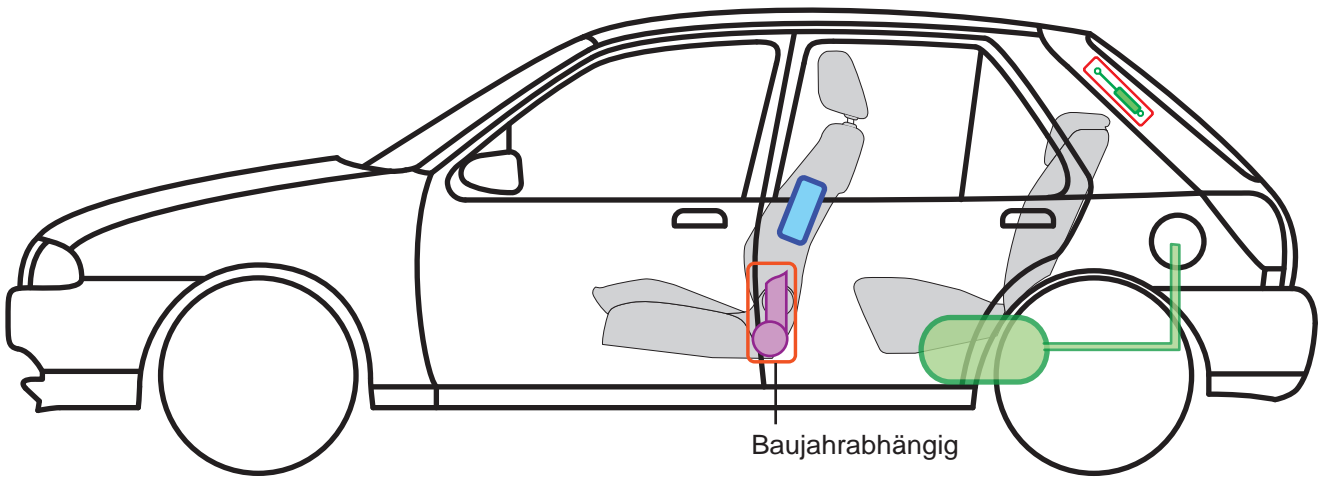
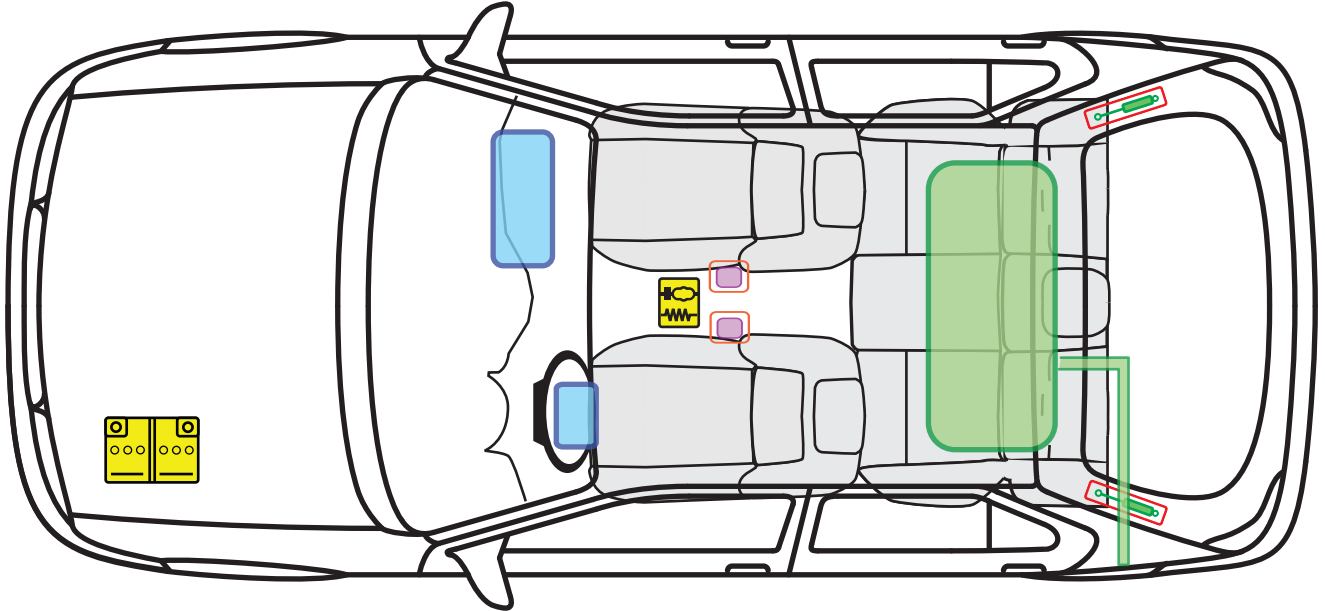

Legende

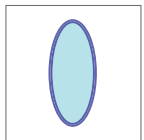

Airbag

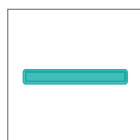

Karosserie-
verstärkung



Steuergerät



Gas-
generator



Überroll-
schutz

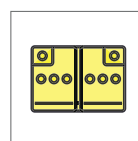

Batterie

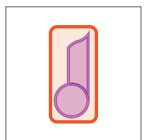

Gurt-
straffer



Gasdruck-
dämpfer

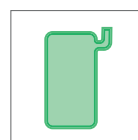

Kraftstoff-
tank





Ford Fiesta

3 Tüer

11/2001 - 09/2008

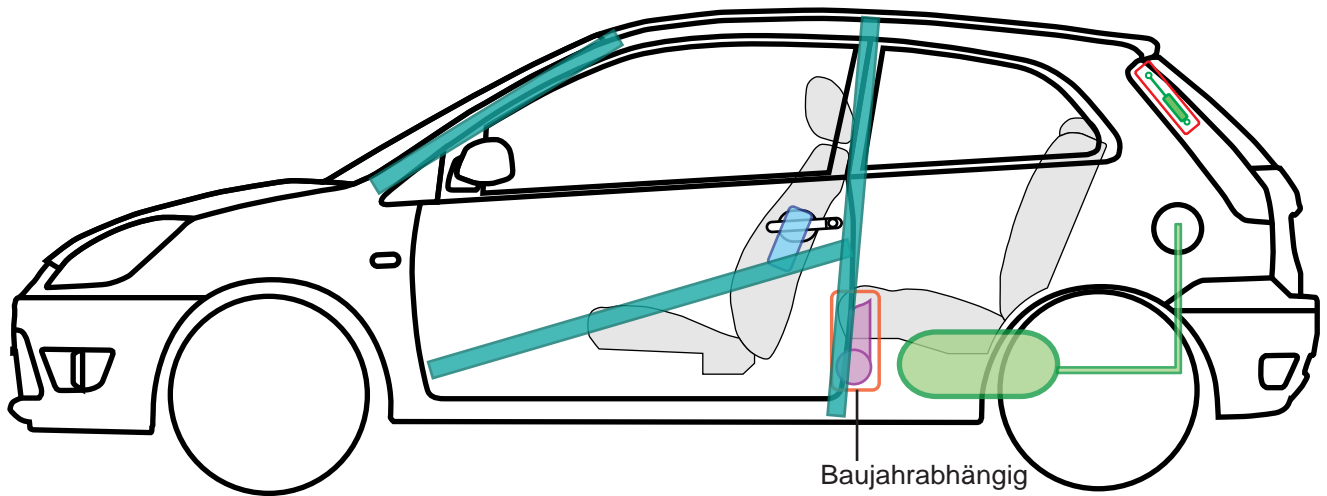
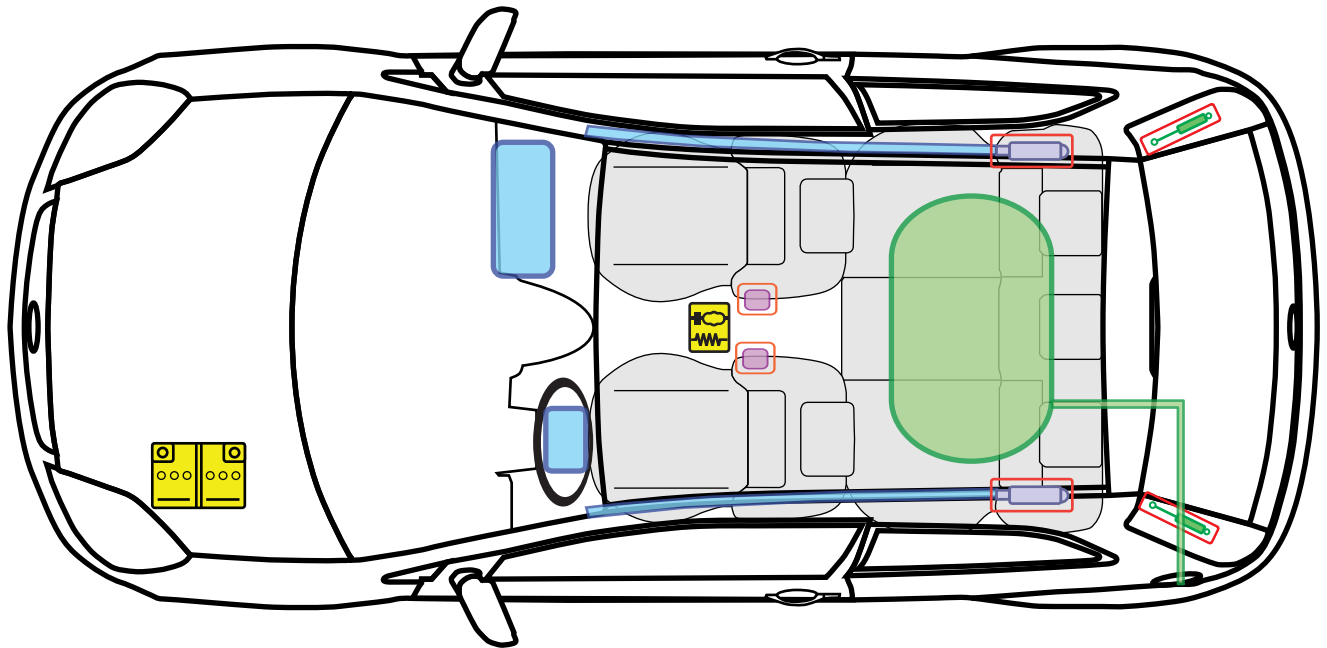

Legende

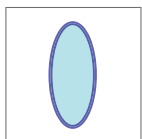

Airbag

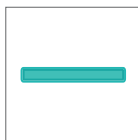

Karosserie-
verstärkung



Steuergerät



Gas-
generator



Überroll-
schutz

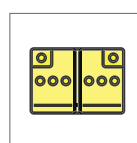

Batterie

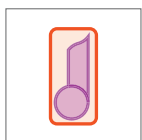

Gurt-
straffer

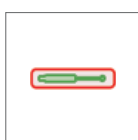

Gasdruck-
dämpfer

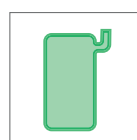

Kraftstoff-
tank

F



Ford Fiesta

5 Tüer

11/2001 - 09/2008

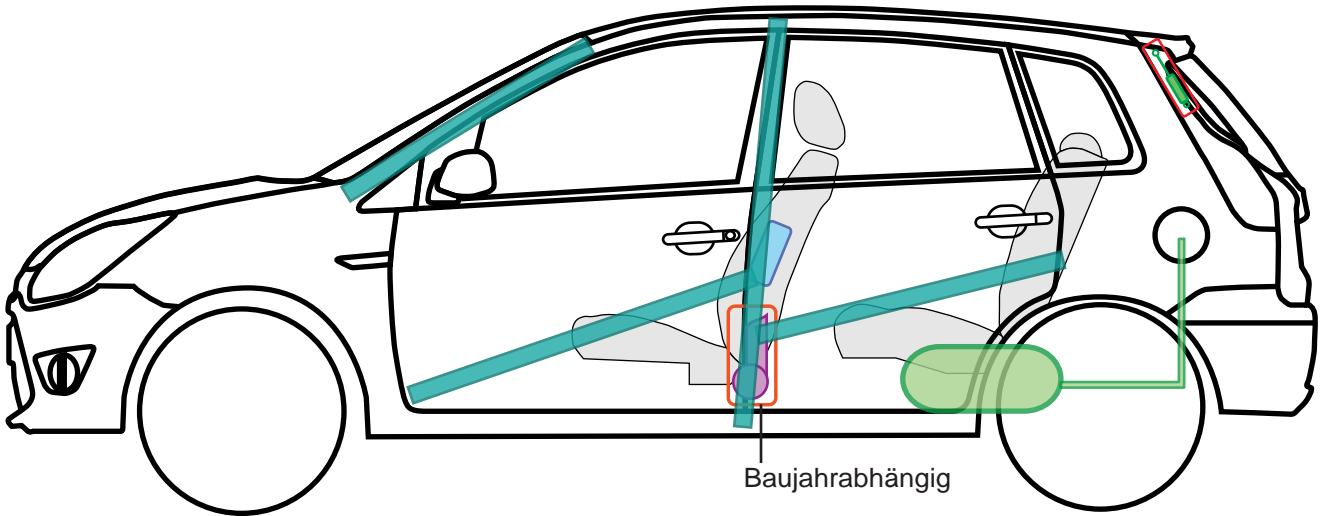
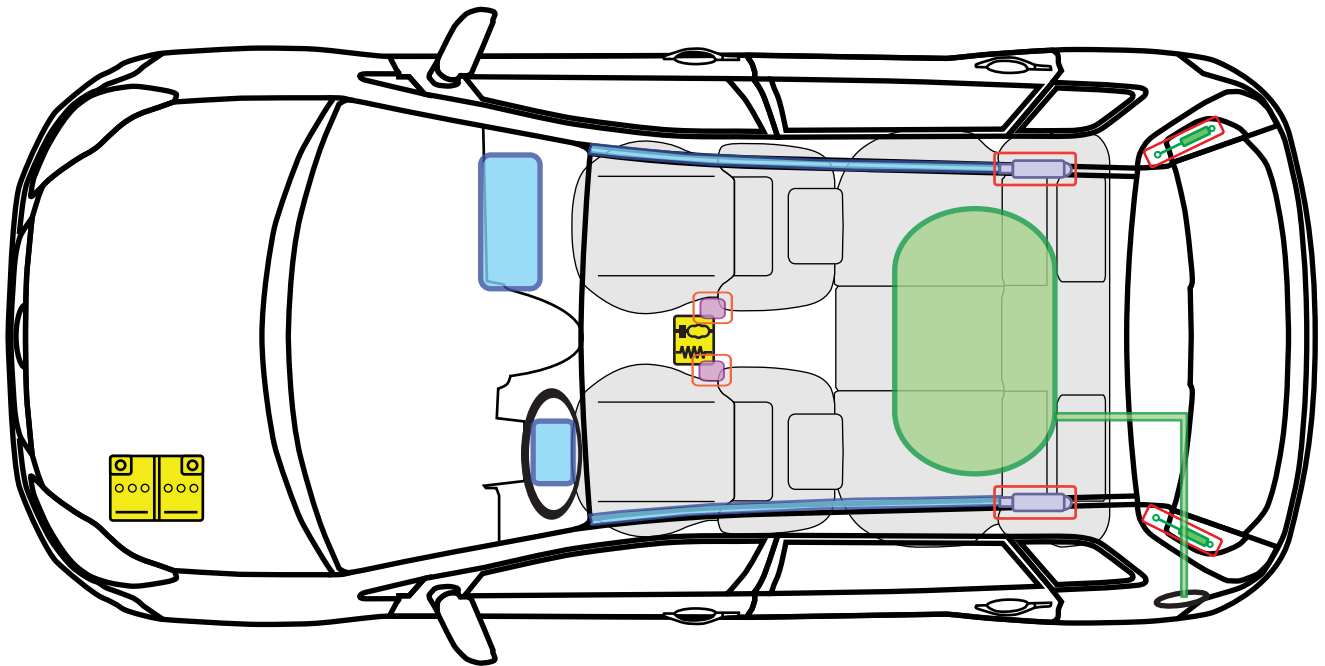

Legende

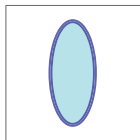

Airbag

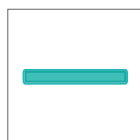

Karosserie-
verstärkung



Steuergerät



Gas-
generator



Überroll-
schutz

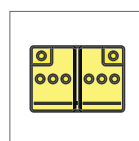

Batterie

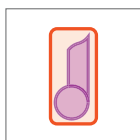

Gurt-
straffer



Gasdruck-
dämpfer

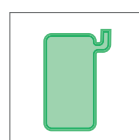

Kraftstoff-
tank

F



Ford Fiesta

3 Türer

06/2008 ->

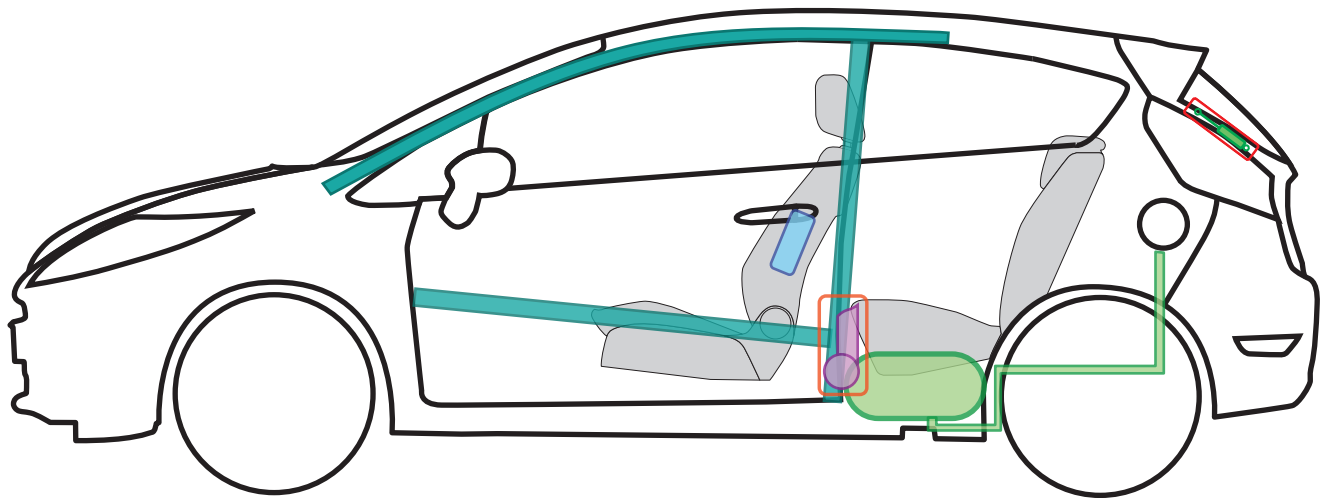
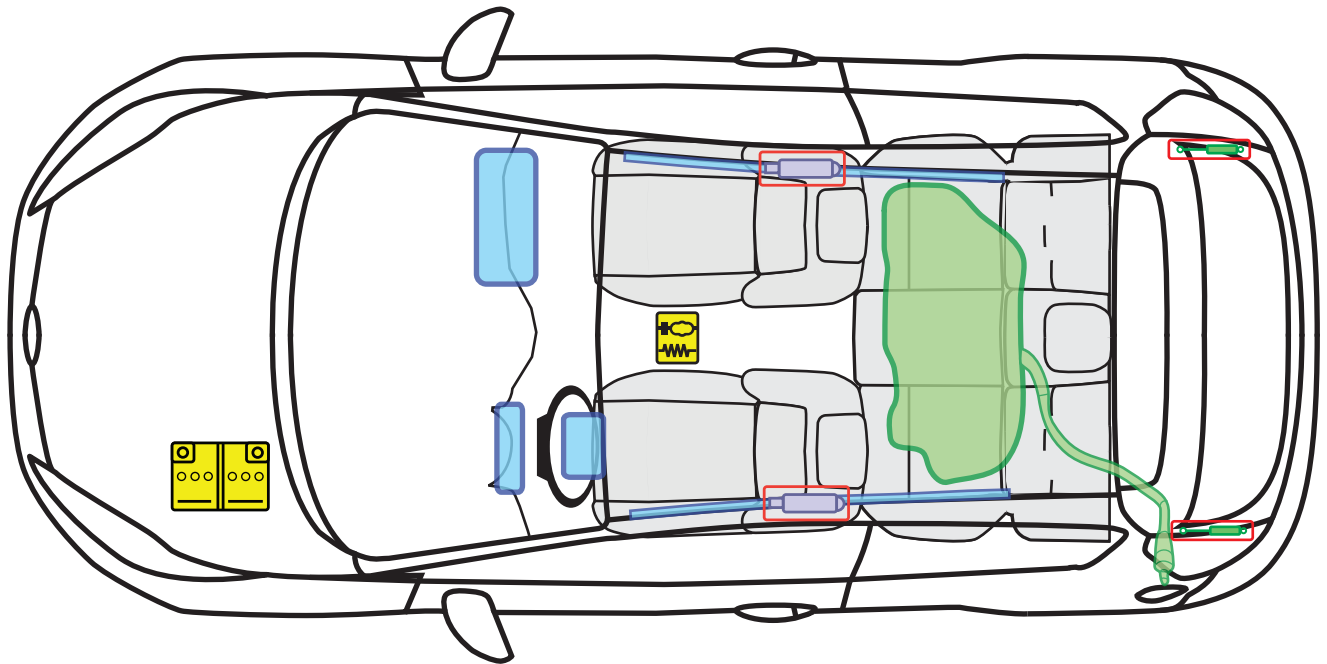

Legende

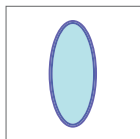

Airbag

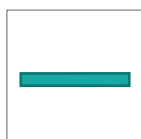

Karosserie-
verstärkung



Steuergerät



Gas-
generator



Überroll-
schutz

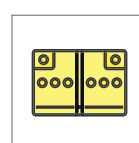

Batterie

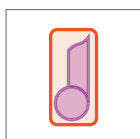

Gurt-
straffer

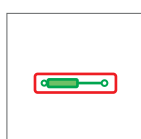

Gasdruck-
dämpfer



Kraftstoff-
tank

F



Ford Fiesta

3 Türer

06/2008 ->

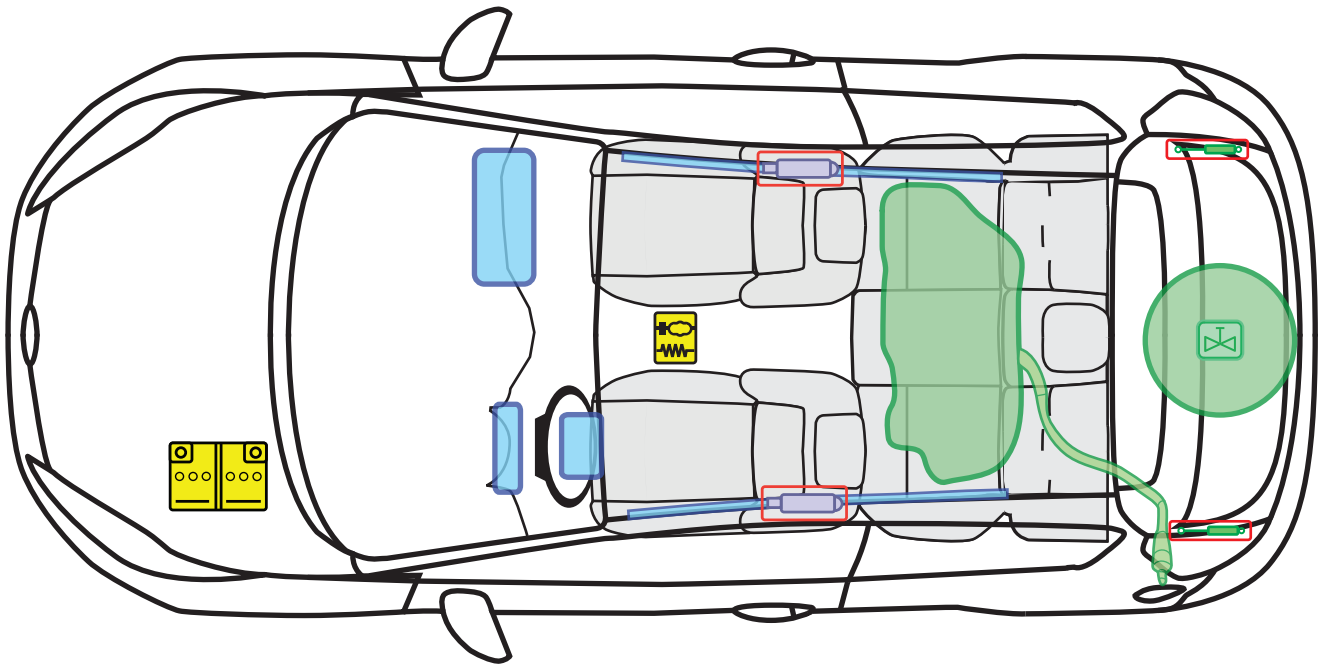

LPG

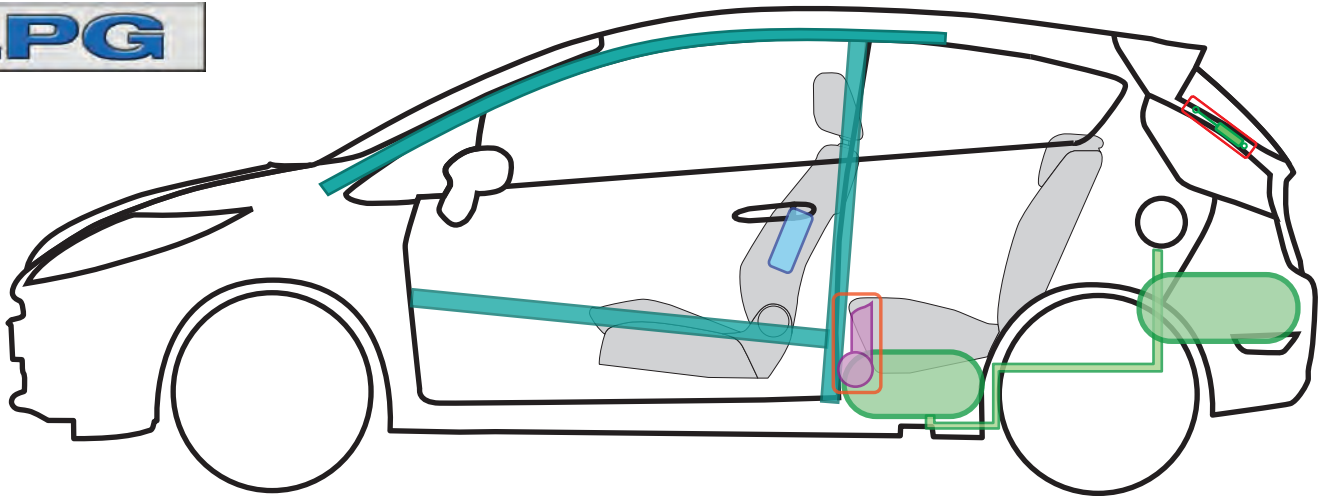

Legende

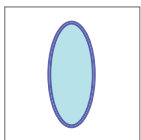

Airbag

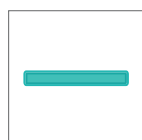

Karosserie-
verstärkung



Steuergerät

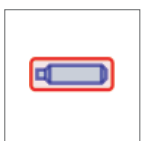

Gas-
generator



Überroll-
schutz

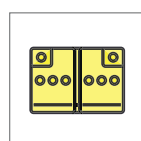

Batterie

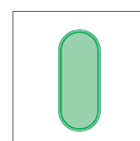

Gastank

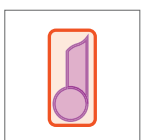

Gurt-
straffer



Gasdruck-
dämpfer

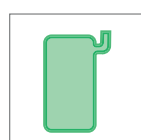

Kraftstoff-
tank

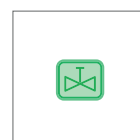

Sicherheits-
ventil

F



Ford Fiesta

5 Tüer

06/2008 ->

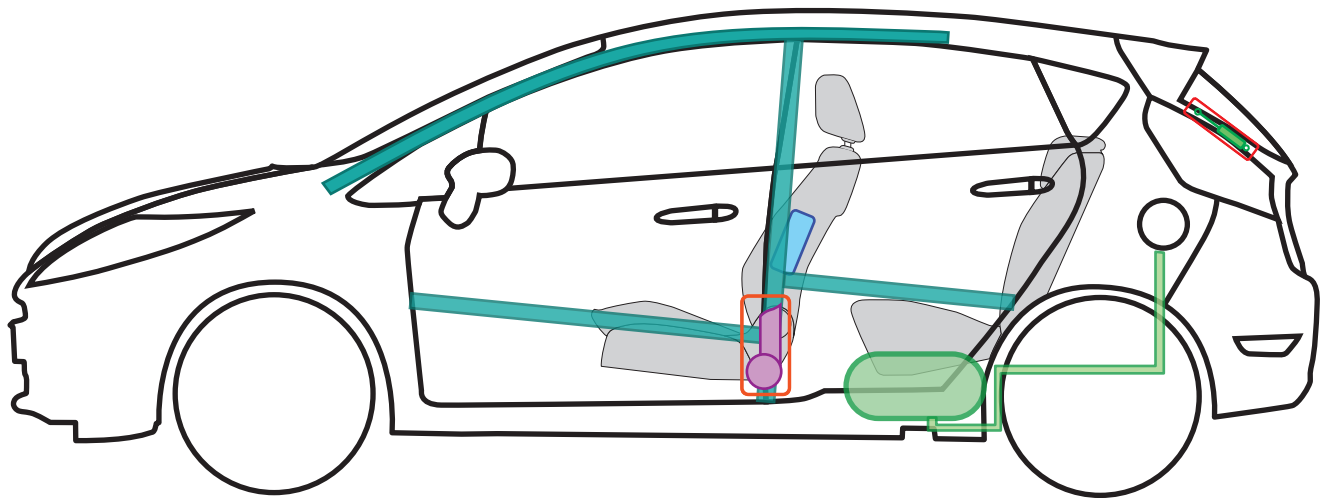
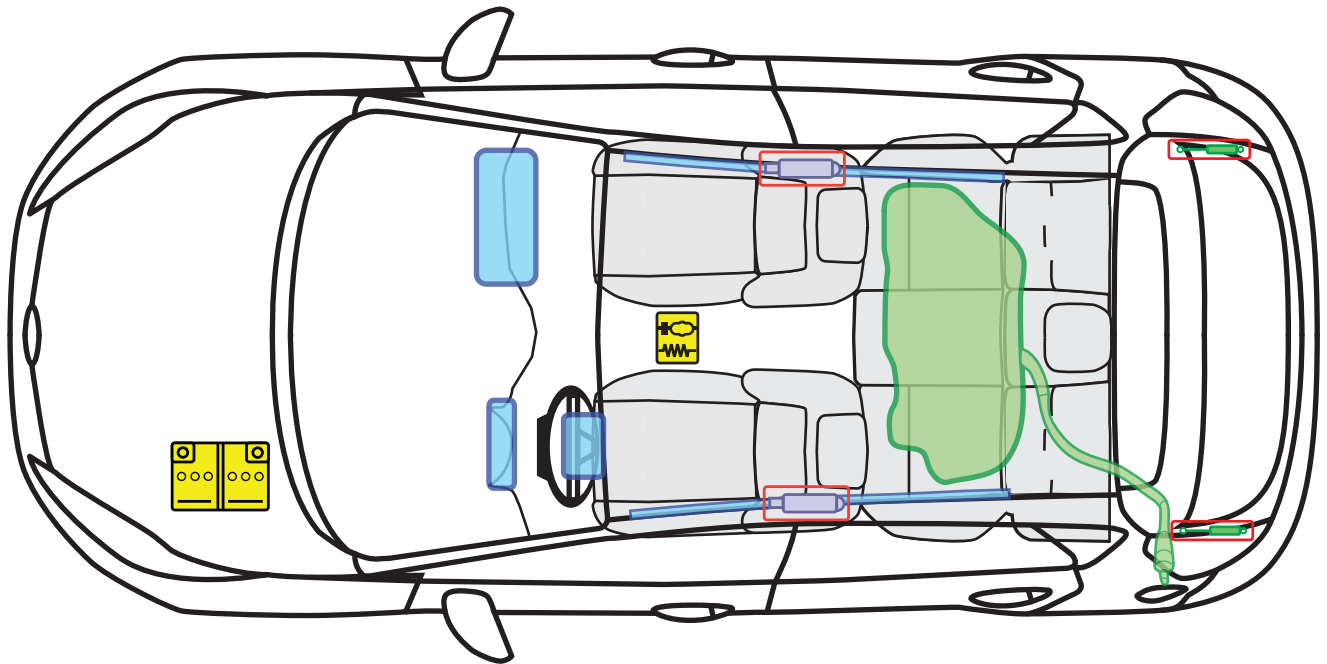

Legende

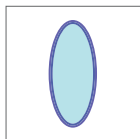

Airbag

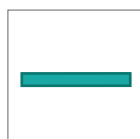

Karosserie-
verstärkung



Steuergerät



Gas-
generator



Überroll-
schutz

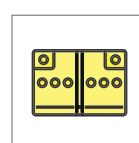

Batterie

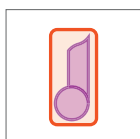

Gurt-
straffer

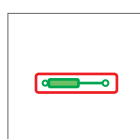

Gasdruck-
dämpfer



Kraftstoff-
tank

F



Ford Fiesta

5 Türer

06/2008 ->

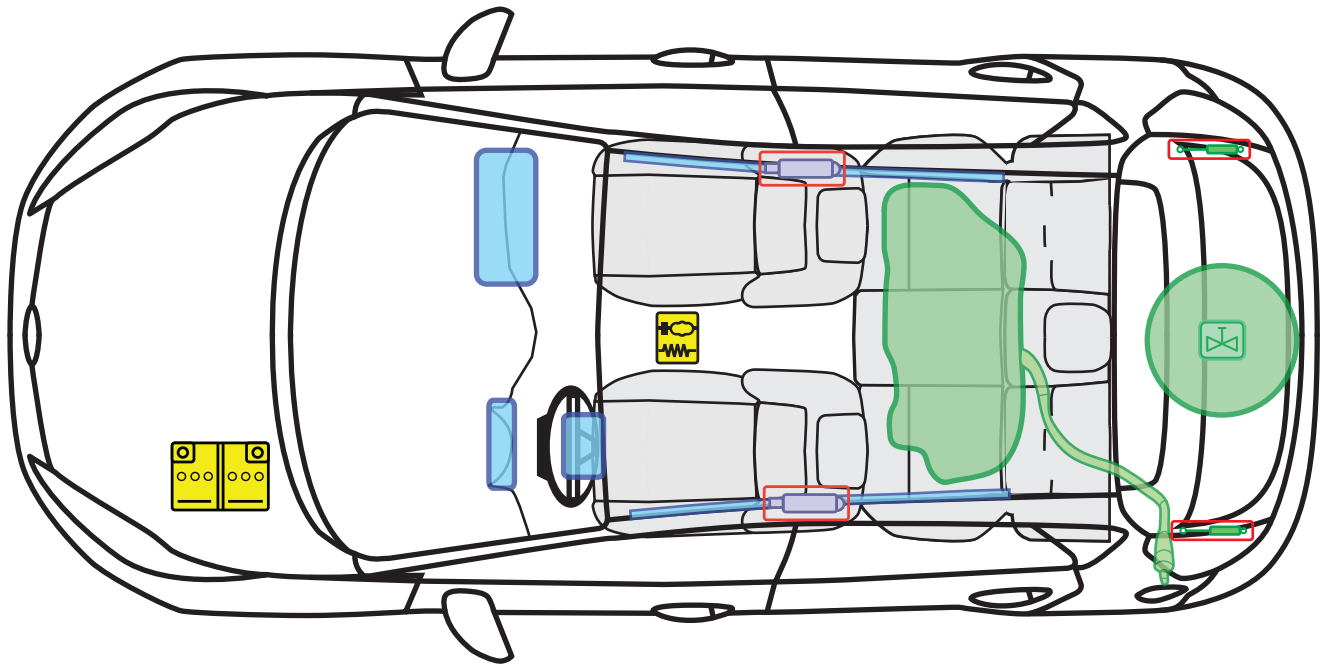

LPG

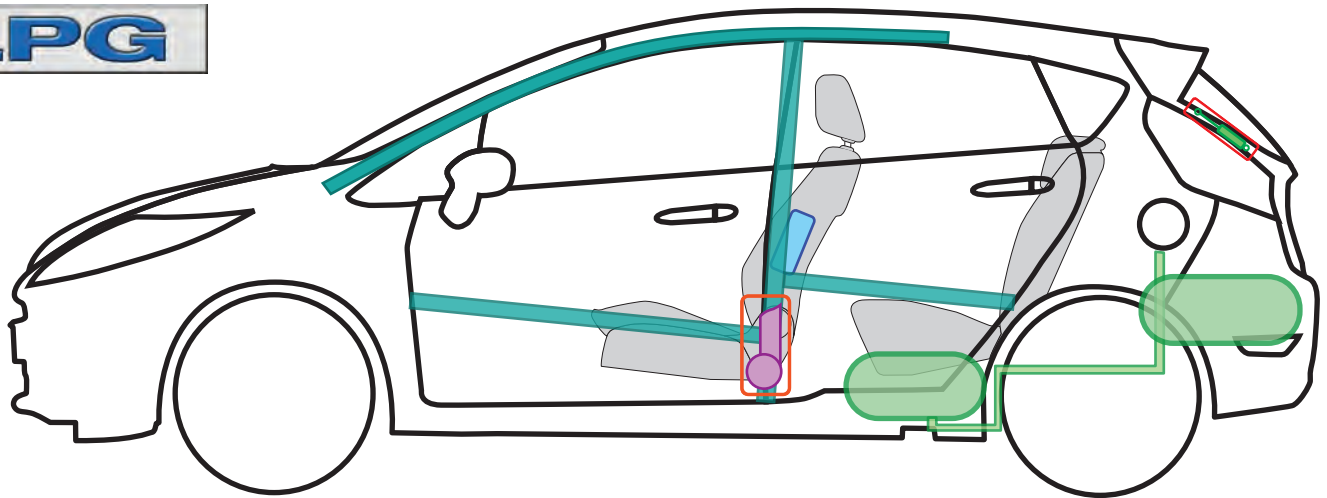

Legende

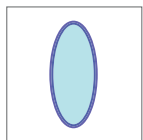

Airbag

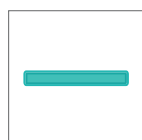

Karosserie-
verstärkung



Steuergerät



Gas-
generator



Überroll-
schutz

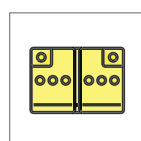

Batterie

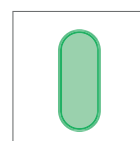

Gastank

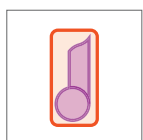

Gurt-
straffer



Gasdruck-
dämpfer

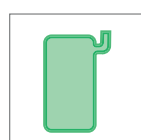

Kraftstoff-
tank

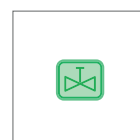

Sicherheits-
ventil

F



Ford Focus

Coupé-Cabriolet

06/2004 ->

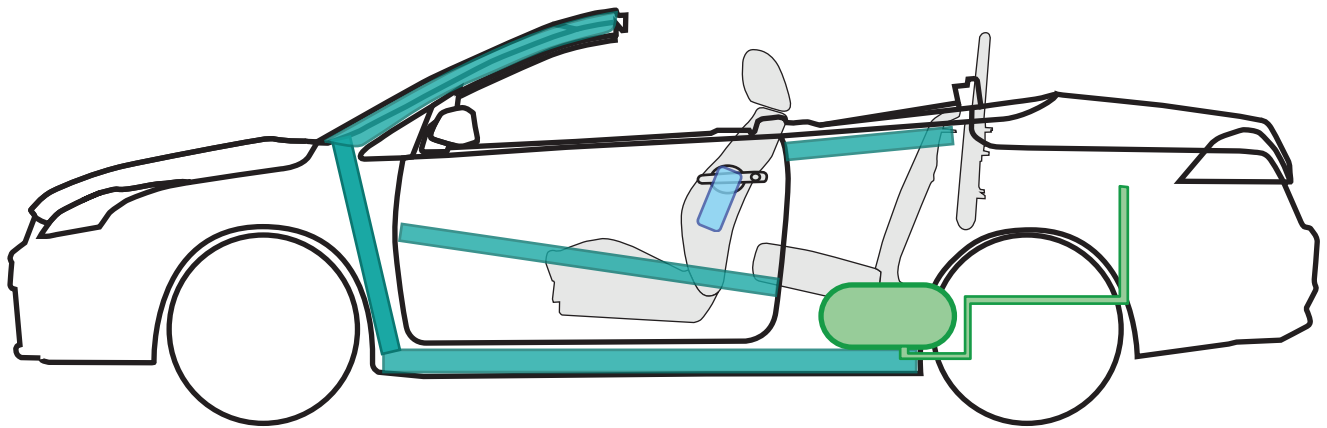
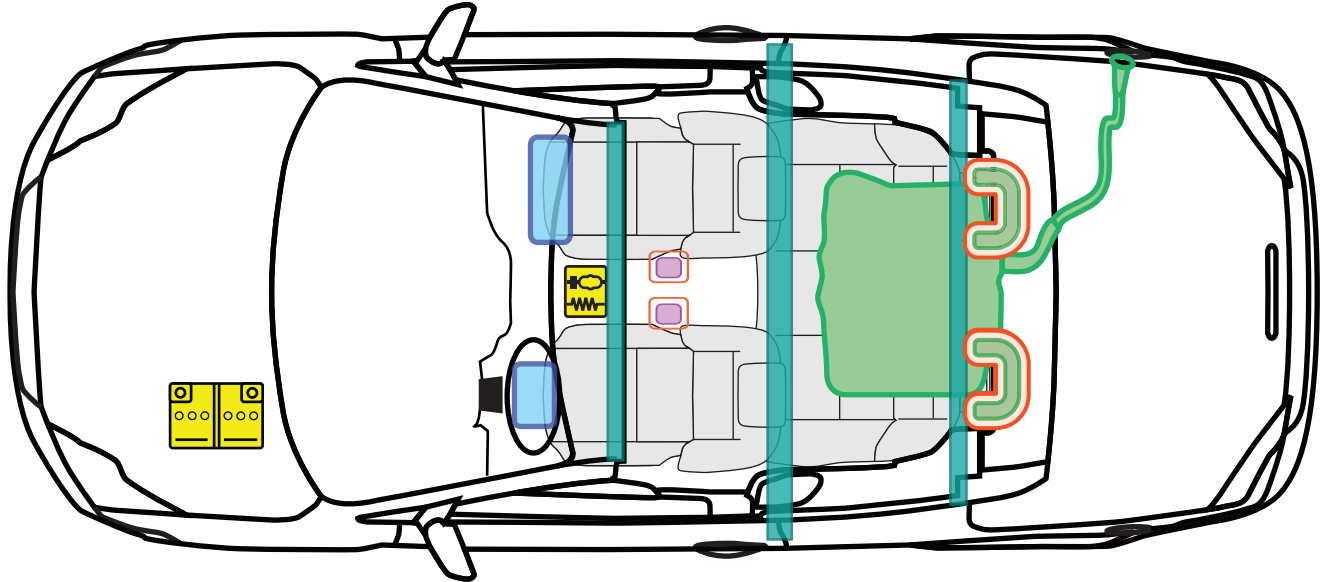

Legende

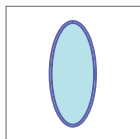

Airbag

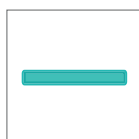

Karosserie-
verstärkung



Steuergerät



Gas-
generator



Überroll-
schutz

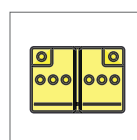

Batterie

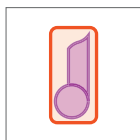

Gurt-
straffer

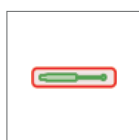

Gasdruck-
dämpfer

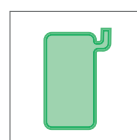

Kraftstoff-
tank





Ford Focus

3 Tüer

08/1999 - 12/2004

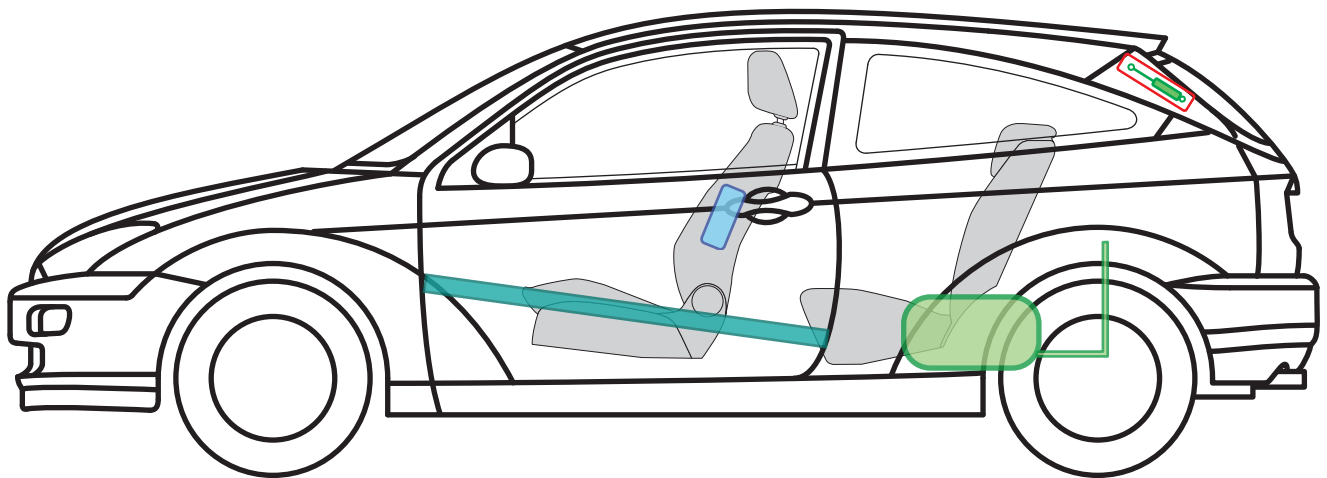
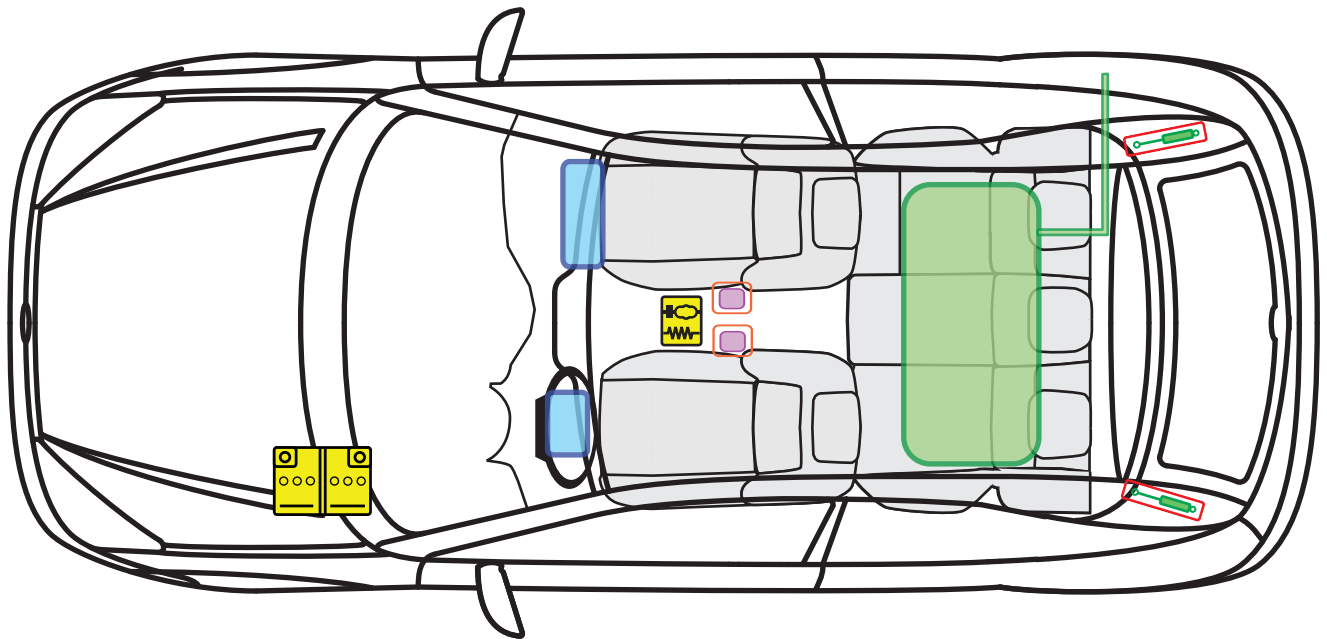

Legende

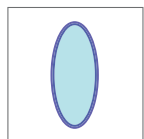

Airbag

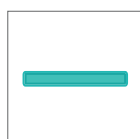

Karosserie-
verstärkung



Steuergerät



Gas-
generator



Überroll-
schutz

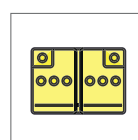

Batterie

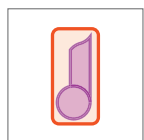

Gurt-
straffer



Gasdruck-
dämpfer

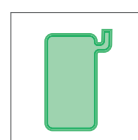

Kraftstoff-
tank

F



Ford Focus

4 Tüer

08/1999 - 12/2004

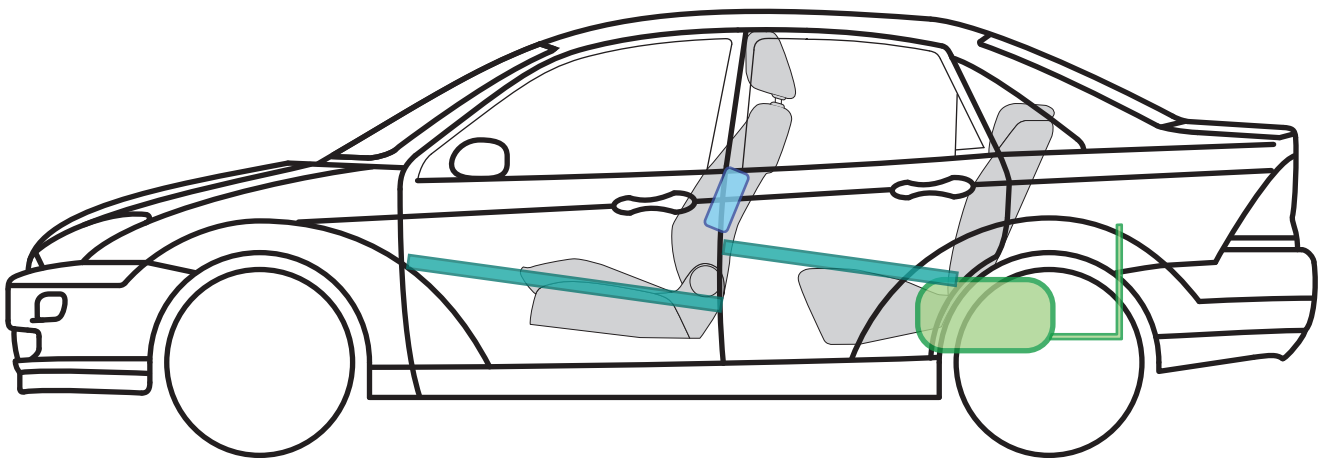
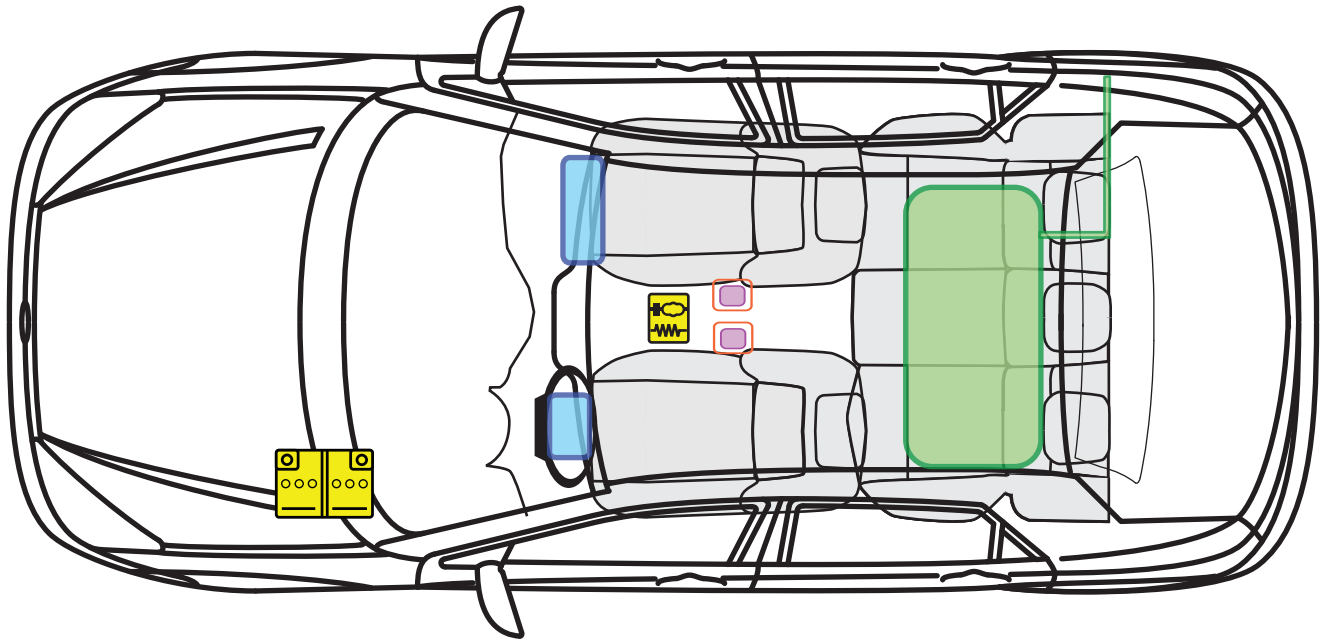

Legende

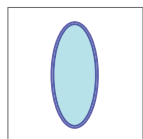

Airbag

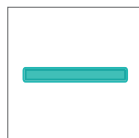

Karosserie-
verstärkung



Steuergerät



Gas-
generator



Überroll-
schutz

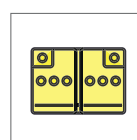

Batterie

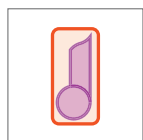

Gurt-
straffer



Gasdruck-
dämpfer

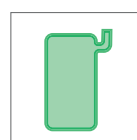

Kraftstoff-
tank





Ford Focus

5 Tüer

08/1999 - 12/2004

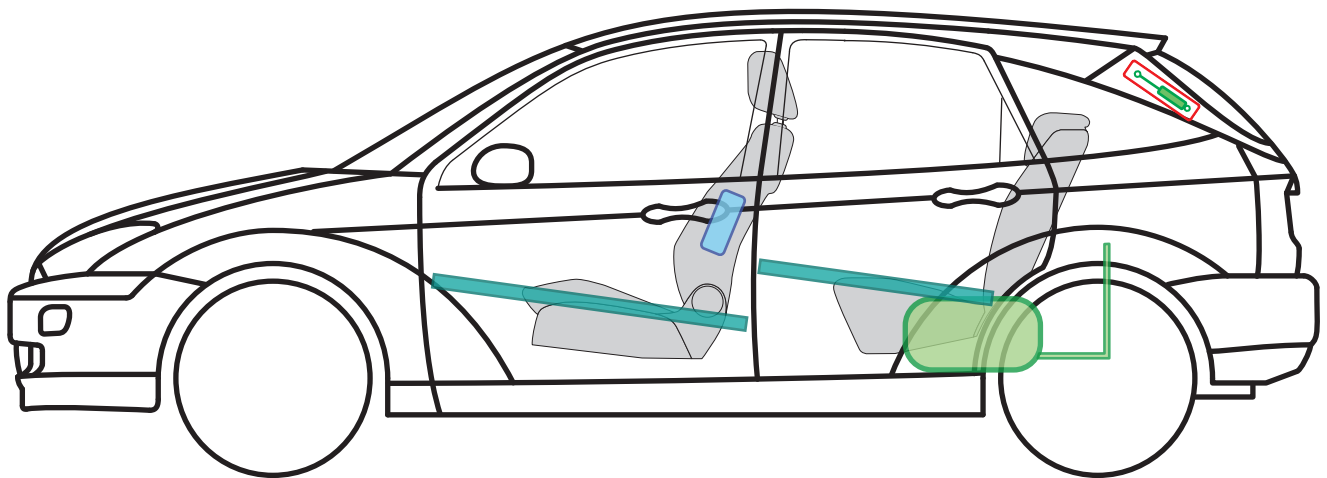
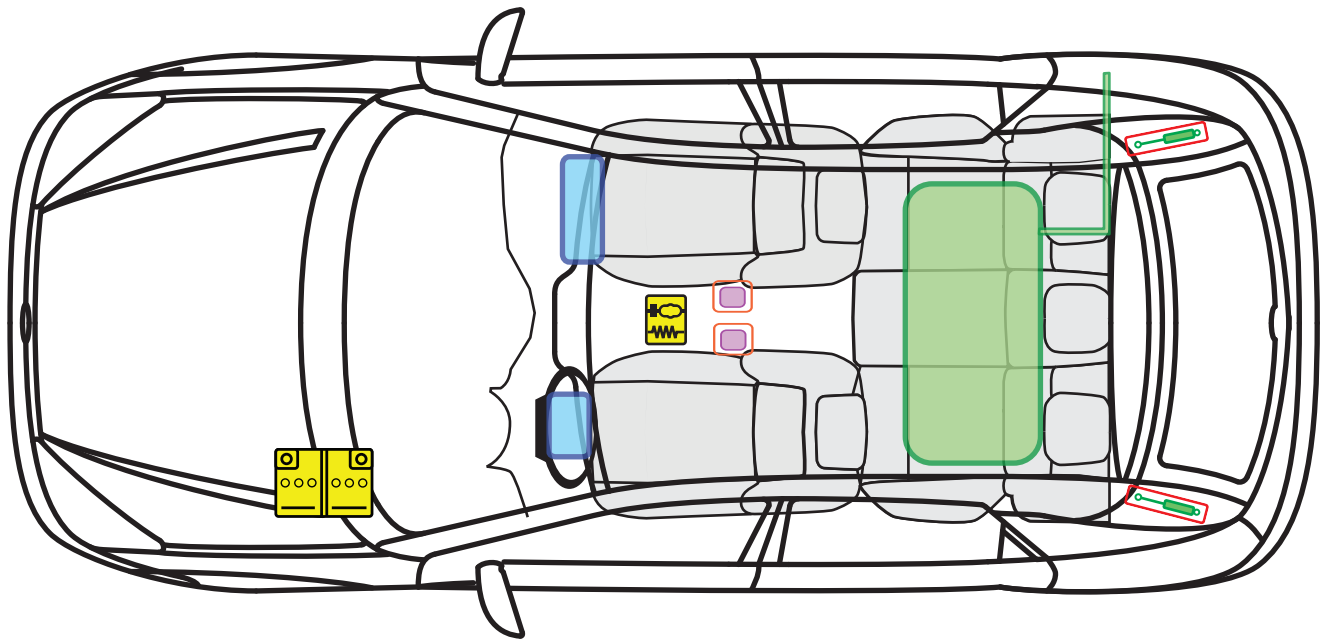

Legende

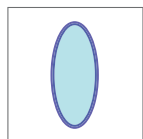

Airbag



Karosserie-
verstärkung



Steuergerät



Gas-
generator



Überroll-
schutz

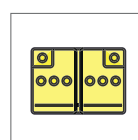

Batterie

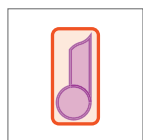

Gurt-
straffer



Gasdruck-
dämpfer

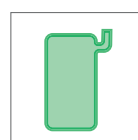

Kraftstoff-
tank

F



Ford Focus Turnier

08/1999 - 12/2004

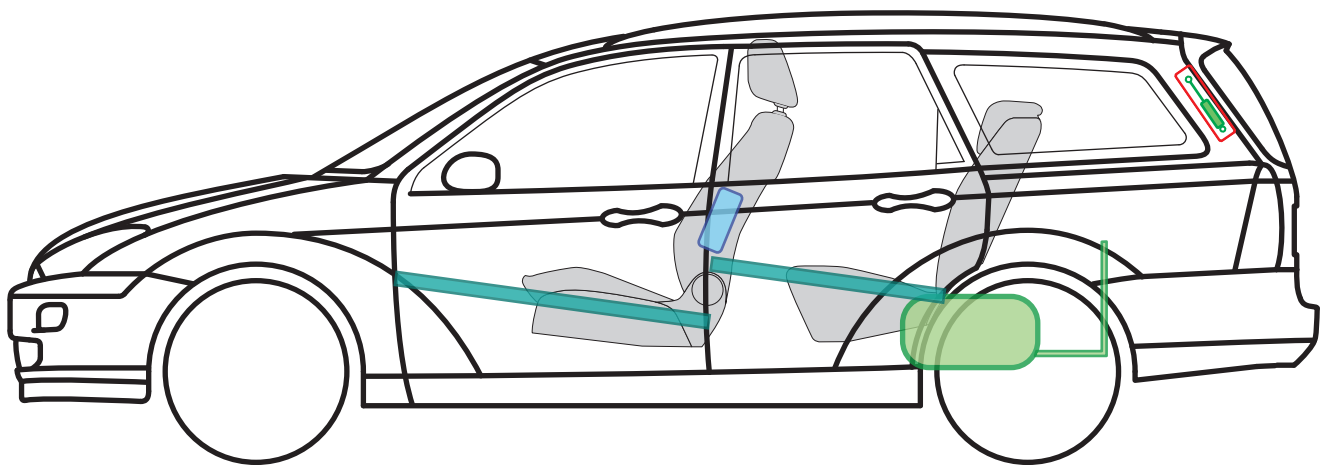
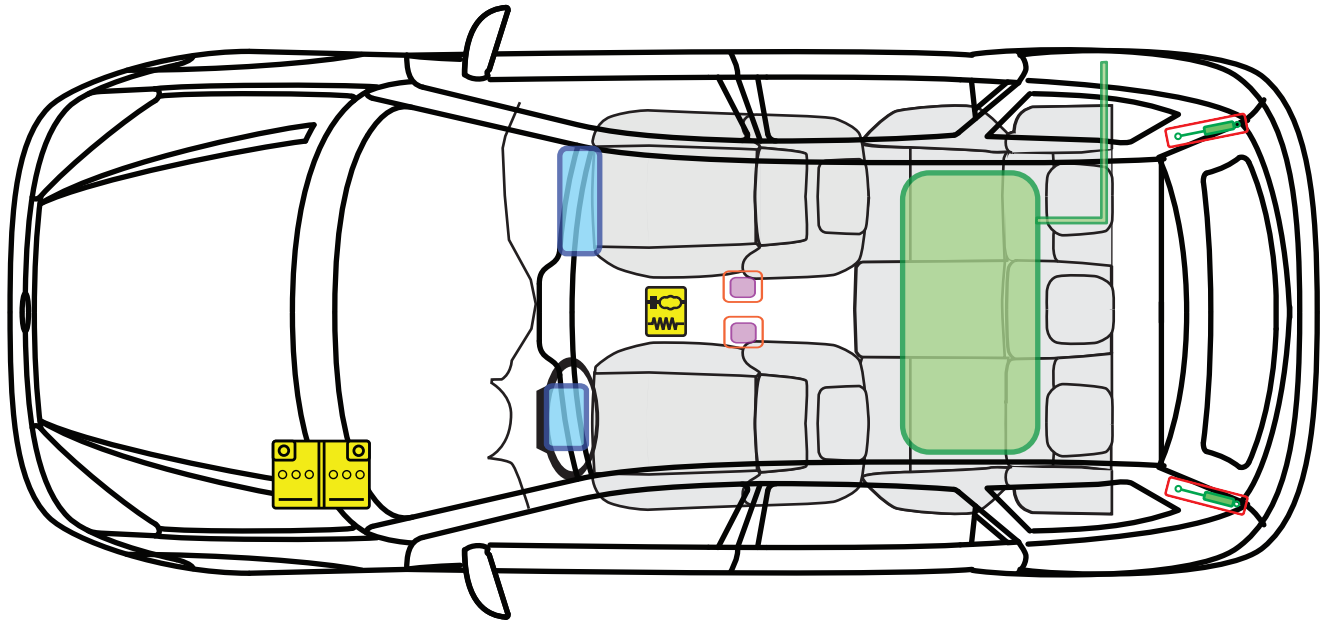

Legende

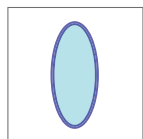

Airbag

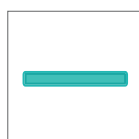

Karosserie-
verstärkung



Steuergerät



Gas-
generator



Überroll-
schutz

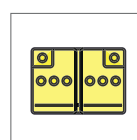

Batterie

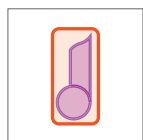

Gurt-
straffer



Gasdruck-
dämpfer

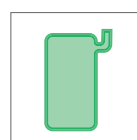

Kraftstoff-
tank

F



Ford Focus 3 Türer

07/2004 - 08/2007

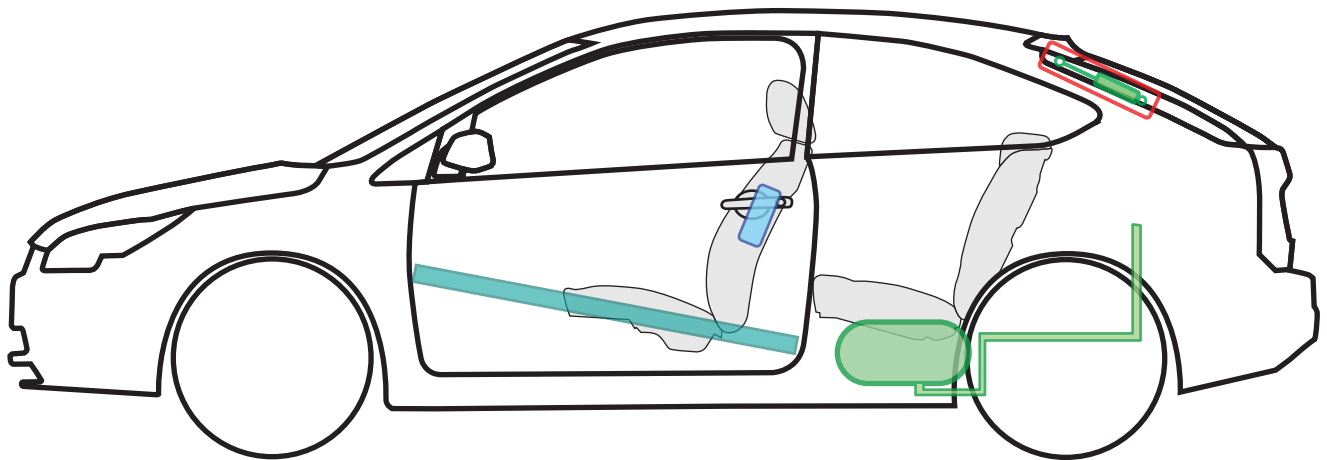
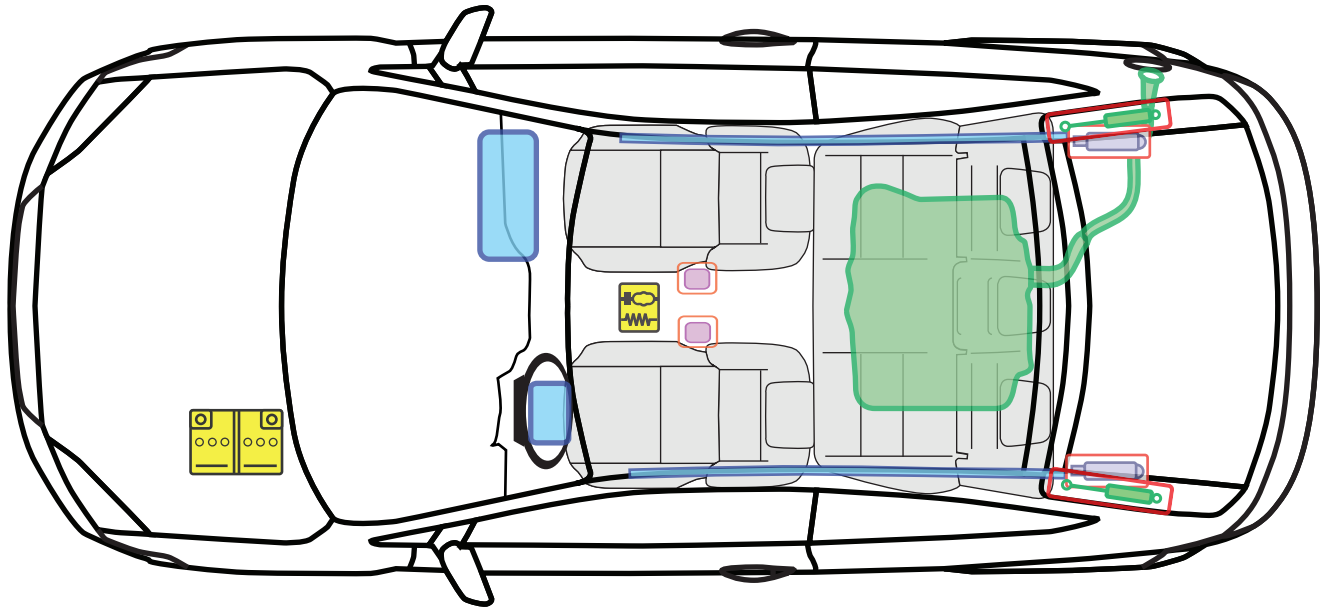

Legende

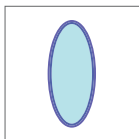

Airbag

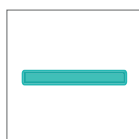

Karosserie-
verstärkung



Steuergerät



Gas-
generator



Überroll-
schutz

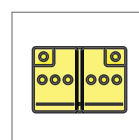

Batterie

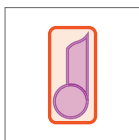

Gurt-
straffer

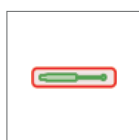

Gasdruck-
dämpfer

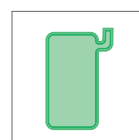

Kraftstoff-
tank





Ford Focus 3 Türer

07/2004 - 08/2007

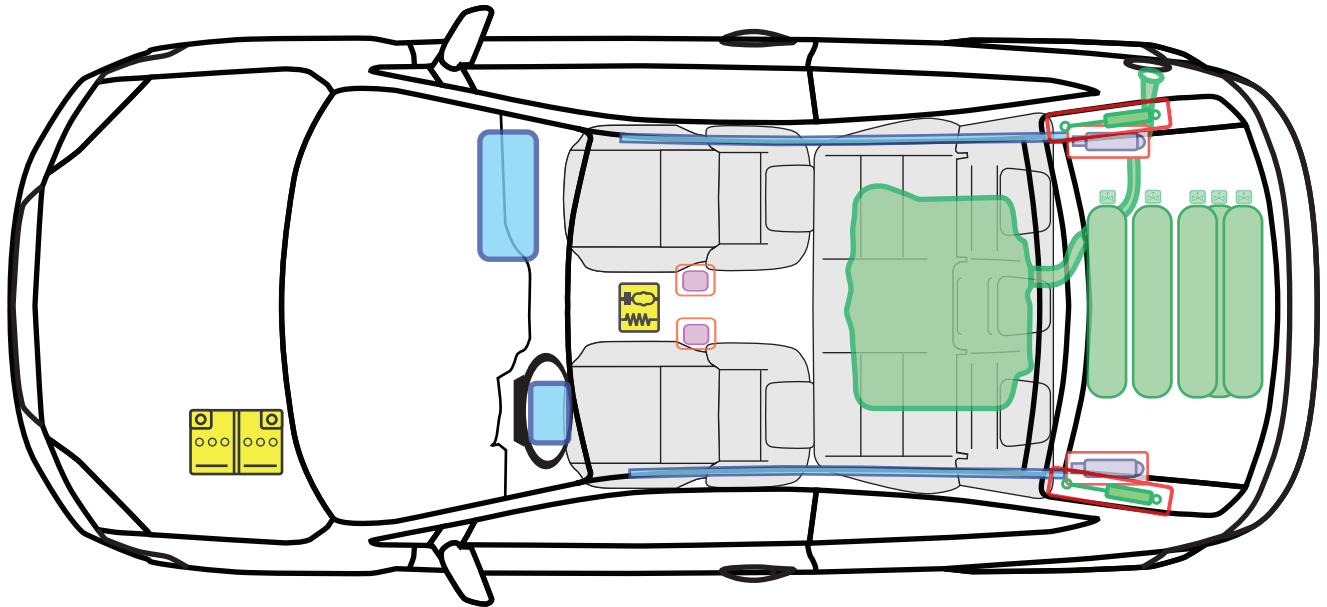

CNG

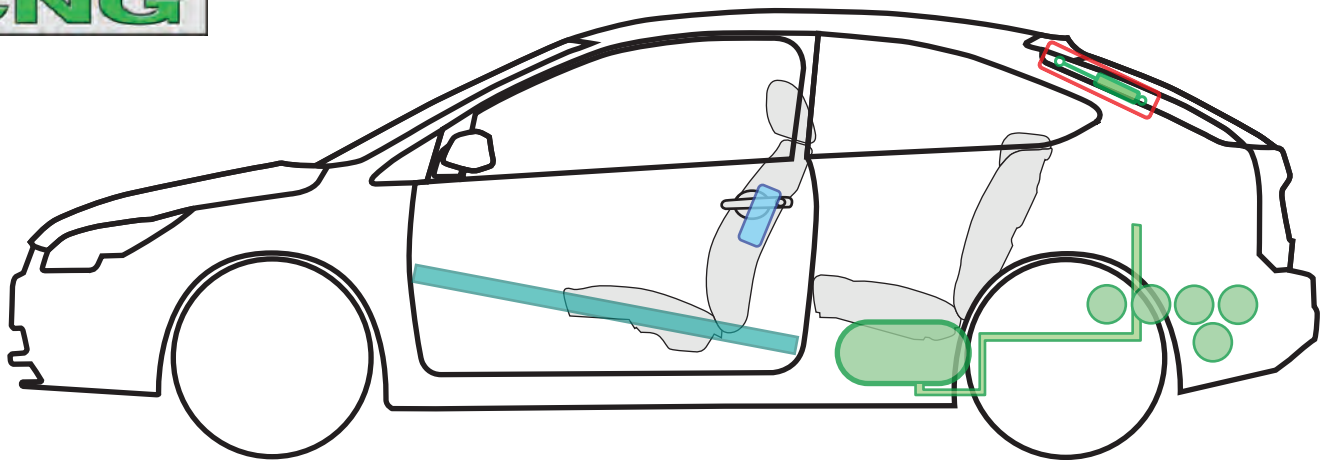

Legende

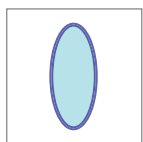

Airbag

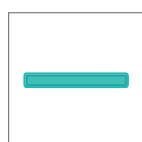

Karosserie-
verstärkung



Steuergerät



Gas-
generator



Überroll-
schutz

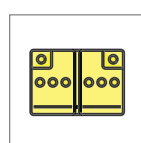

Batterie

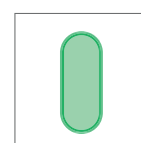

Gastank

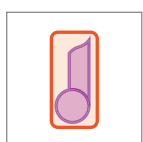

Gurt-
straffer

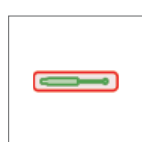

Gasdruck-
dämpfer



Kraftstoff-
tank

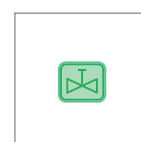

Sicherheits-
ventil

F



Ford Focus 3 Türer

07/2004 - 08/2007

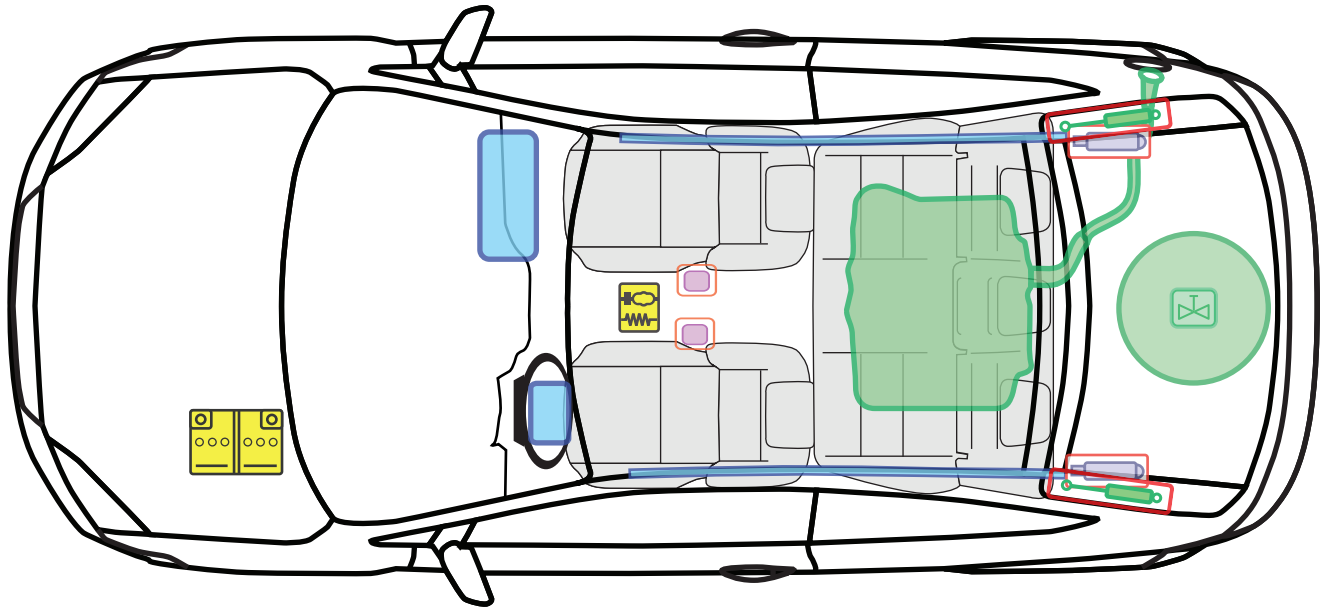

LPG

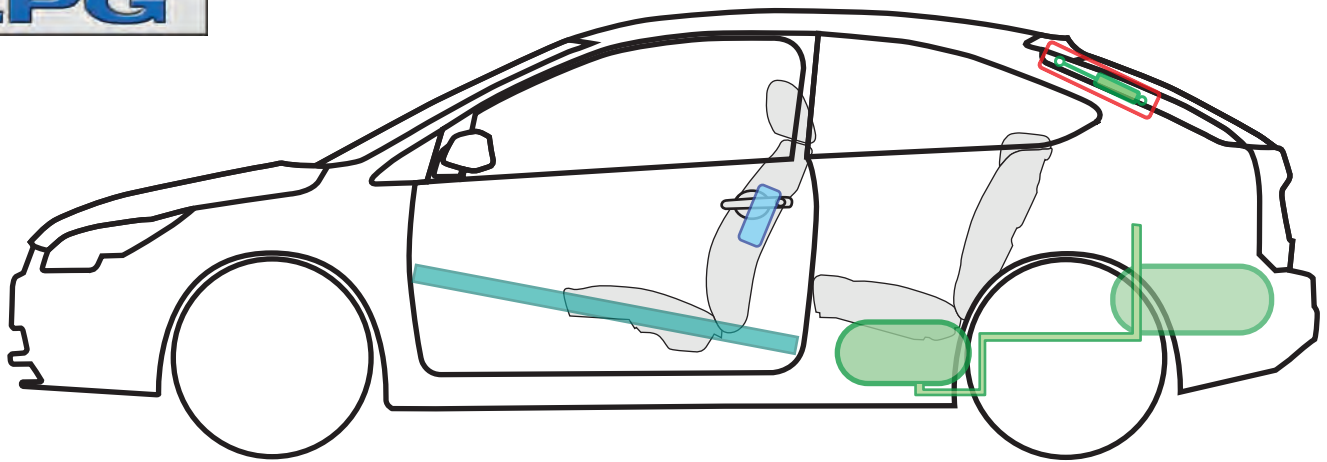

Legende

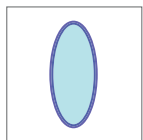

Airbag

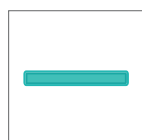

Karosserie-
verstärkung



Steuergerät



Gas-
generator



Überroll-
schutz

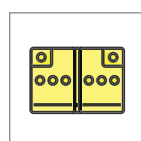

Batterie

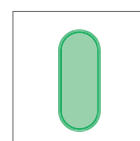

Gastank

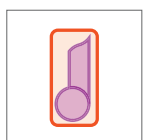

Gurt-
straffer



Gasdruck-
dämpfer

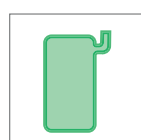

Kraftstoff-
tank

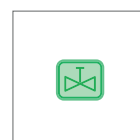

Sicherheits-
ventil

F



Ford Focus

4 Tüer

07/2004- 08/2007

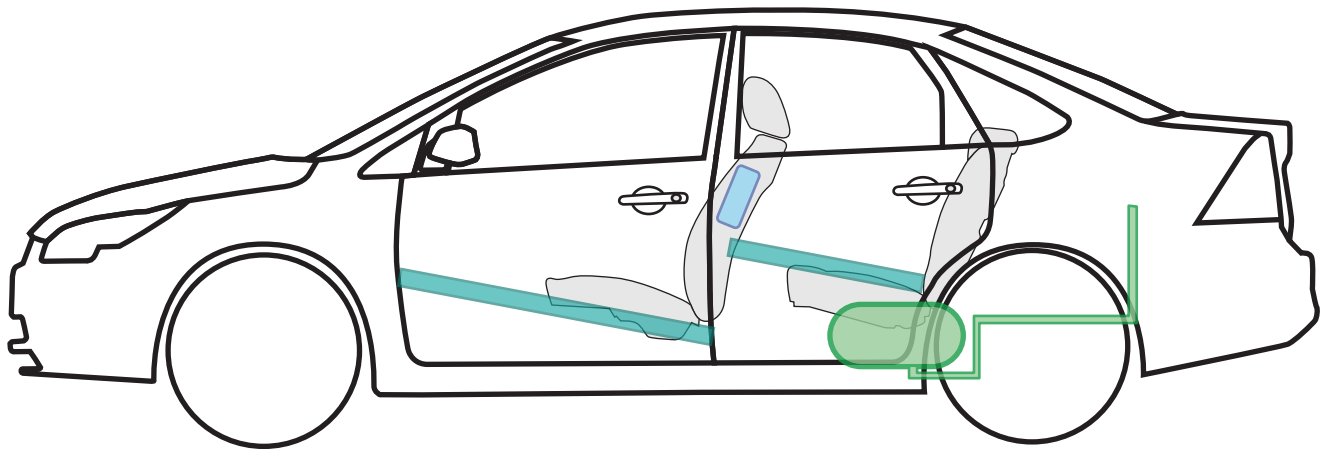
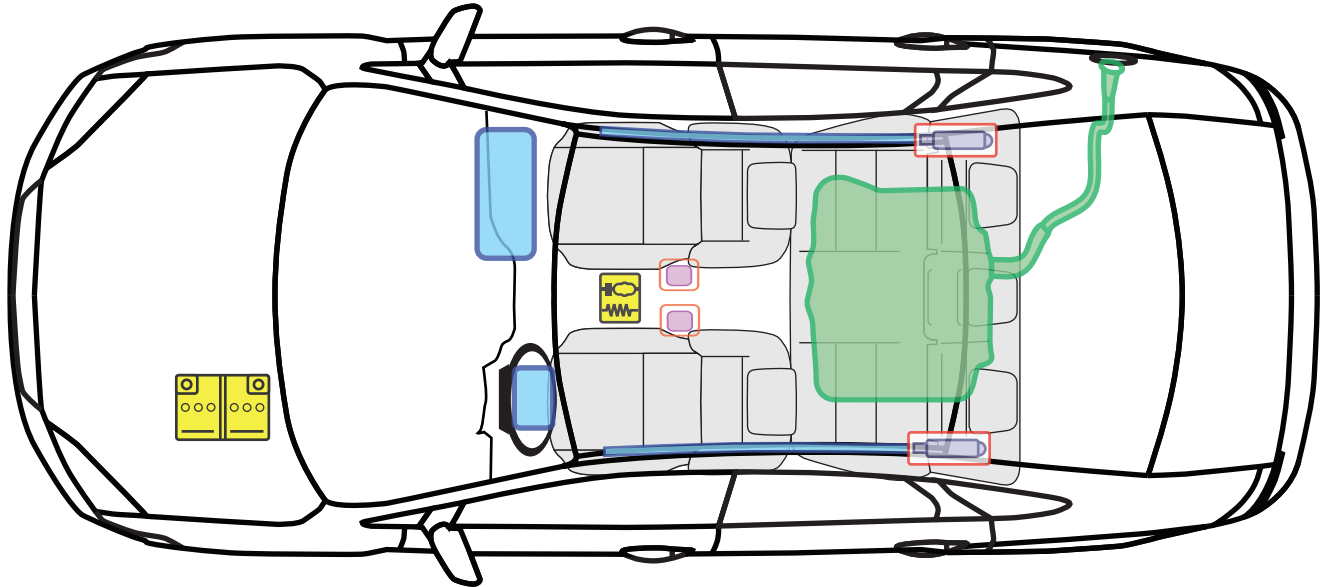

Legende

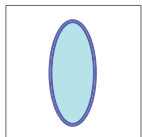

Airbag

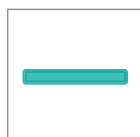

Karosserie-
verstärkung



Steuergerät



Gas-
generator



Überroll-
schutz

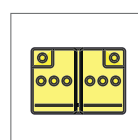

Batterie

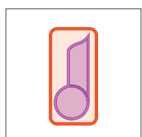

Gurt-
straffer



Gasdruck-
dämpfer



Kraftstoff-
tank

F



Ford Focus

5 Tüer

07/2004- 08/2007

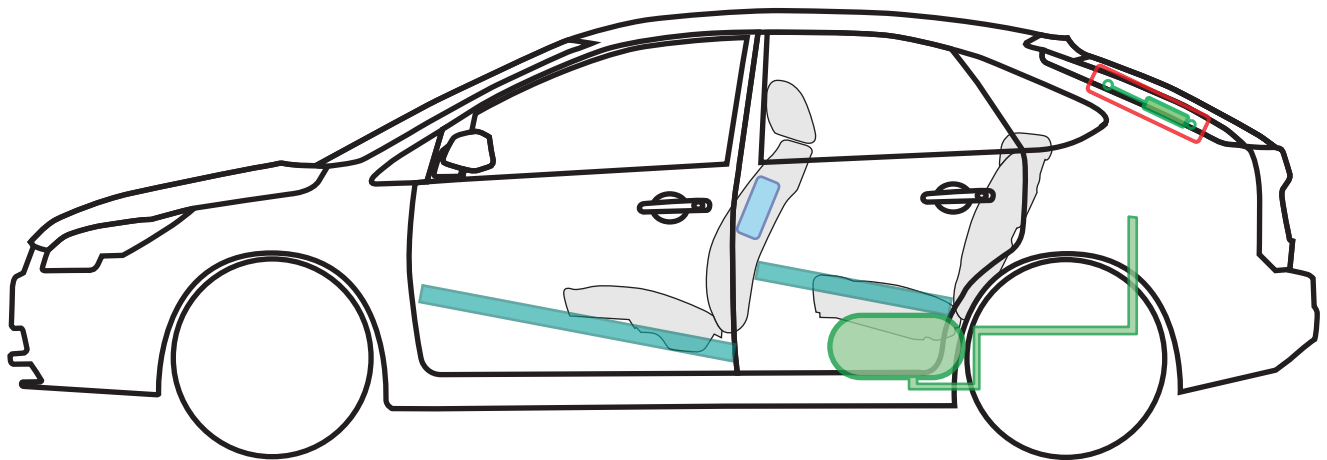
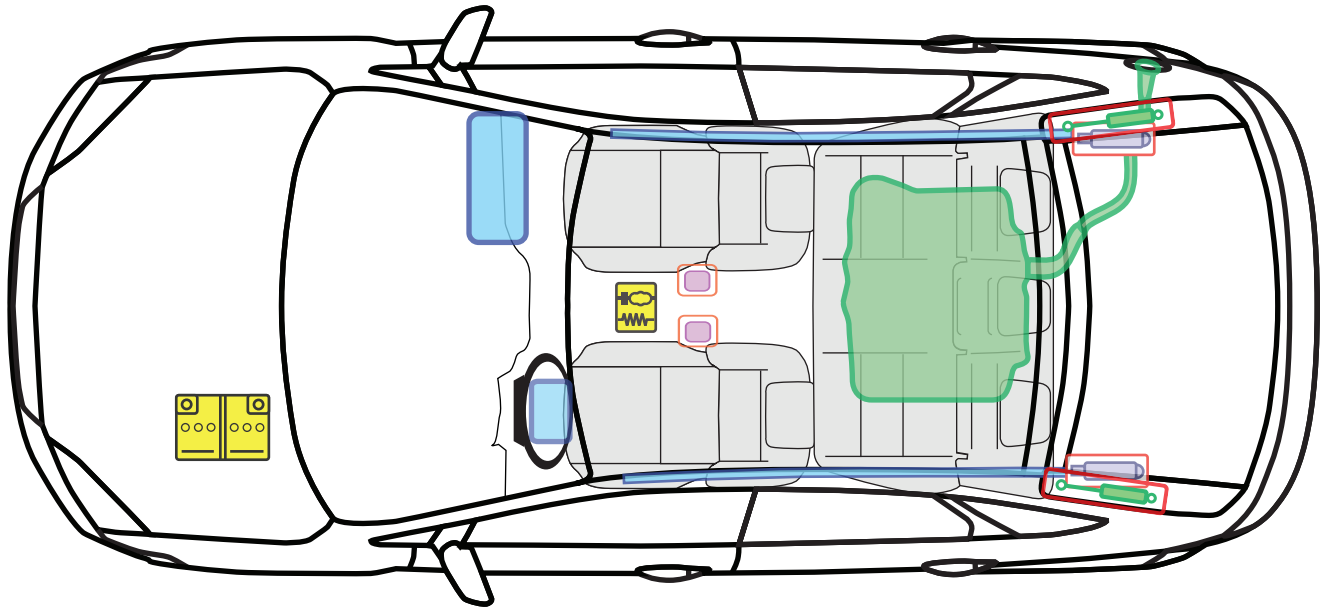

Legende

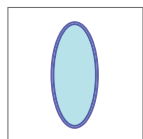

Airbag

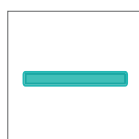

Karosserie-
verstärkung



Steuergerät



Gas-
generator



Überroll-
schutz

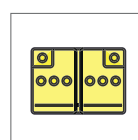

Batterie

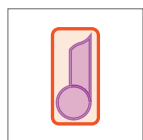

Gurt-
straffer



Gasdruck-
dämpfer

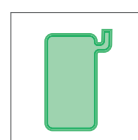

Kraftstoff-
tank

F



Ford Focus 5 Tüer

07/2004- 08/2007

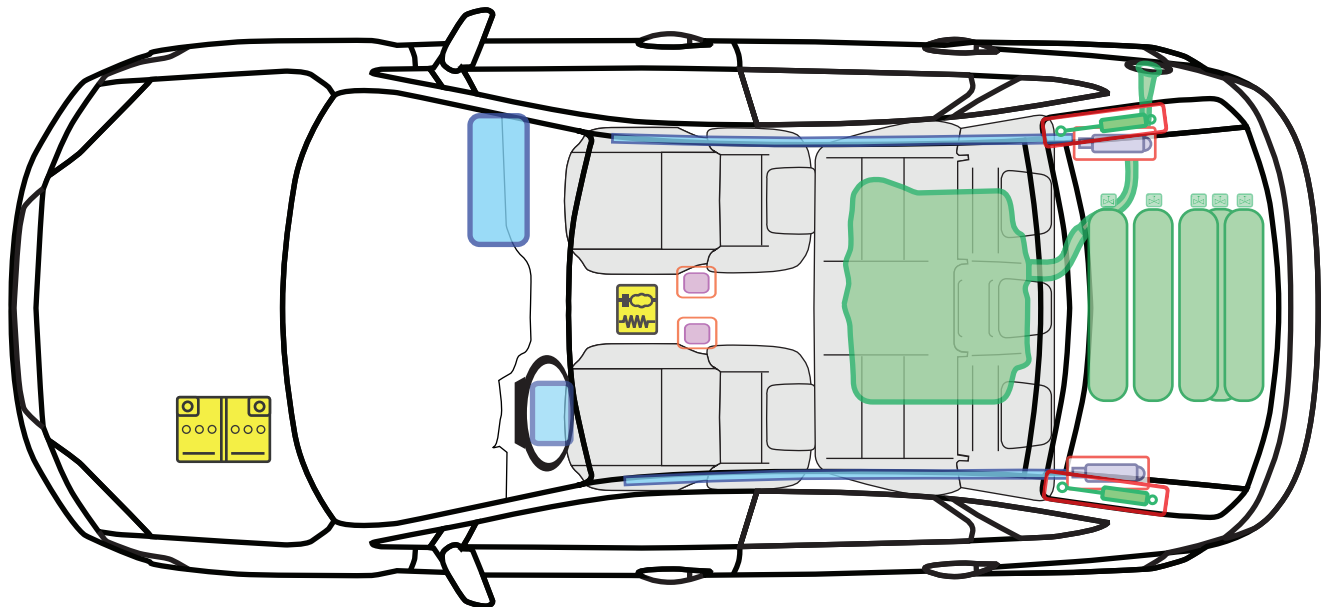

CNG

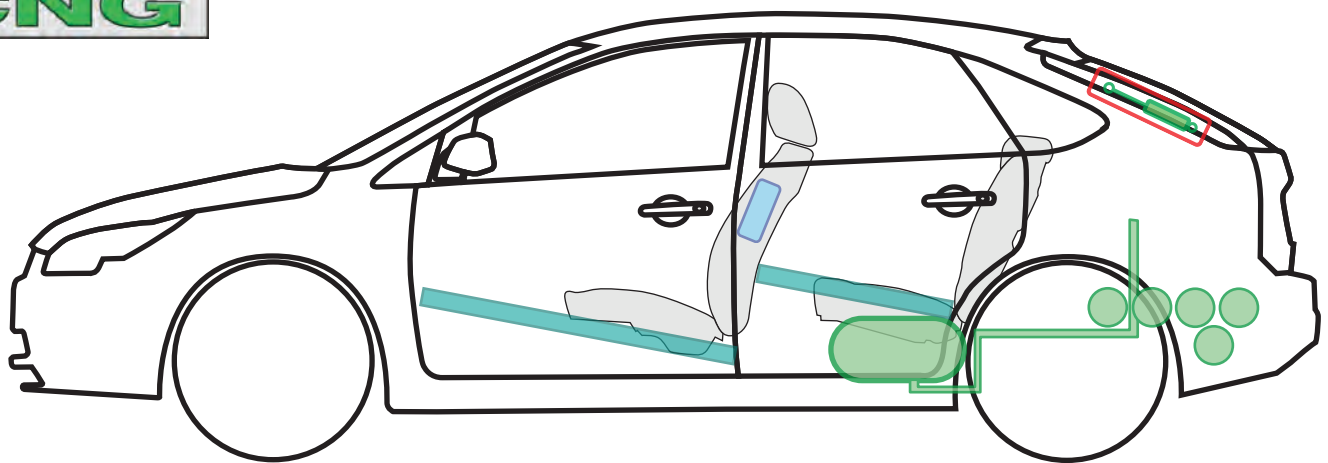

Legende

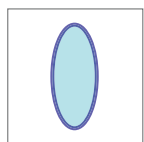

Airbag

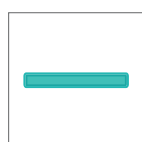

Karosserie-
verstärkung



Steuergerät



Gas-
generator



Überroll-
schutz

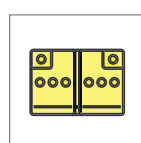

Batterie

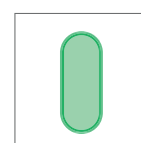

Gastank

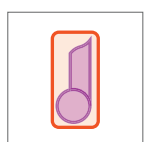

Gurt-
straffer



Gasdruck-
dämpfer



Kraftstoff-
tank

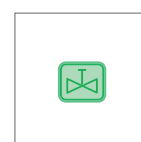

Sicherheits-
ventil





Ford Focus 5 Tüer

07/2004- 08/2007

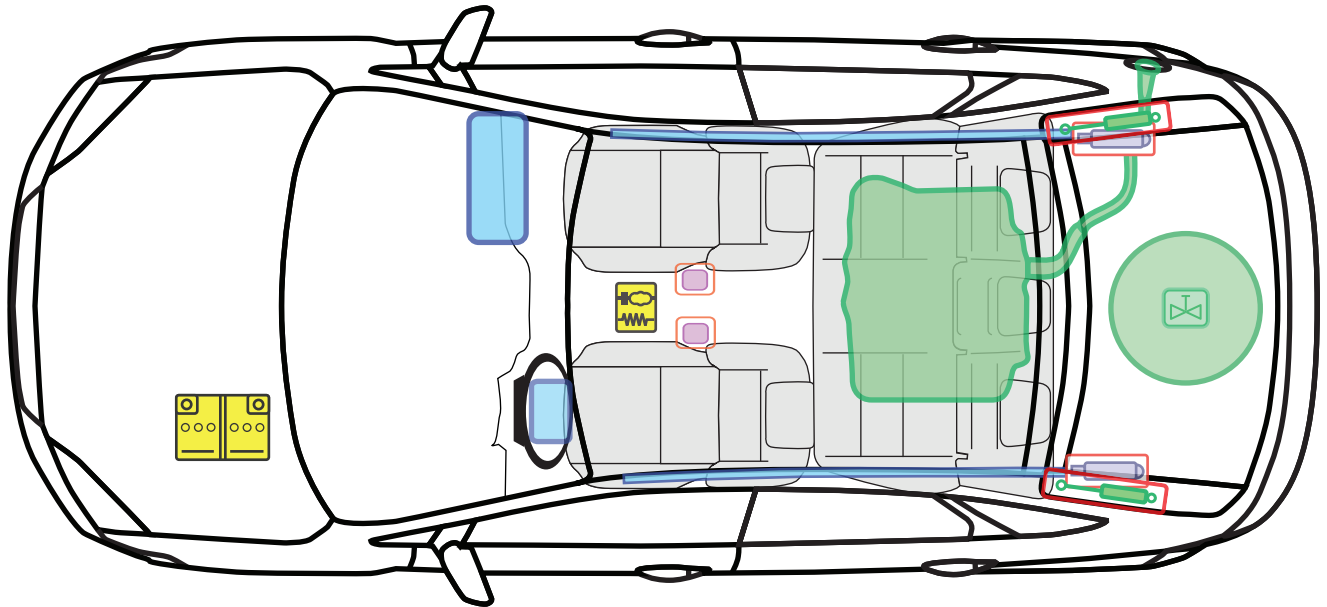

LPG

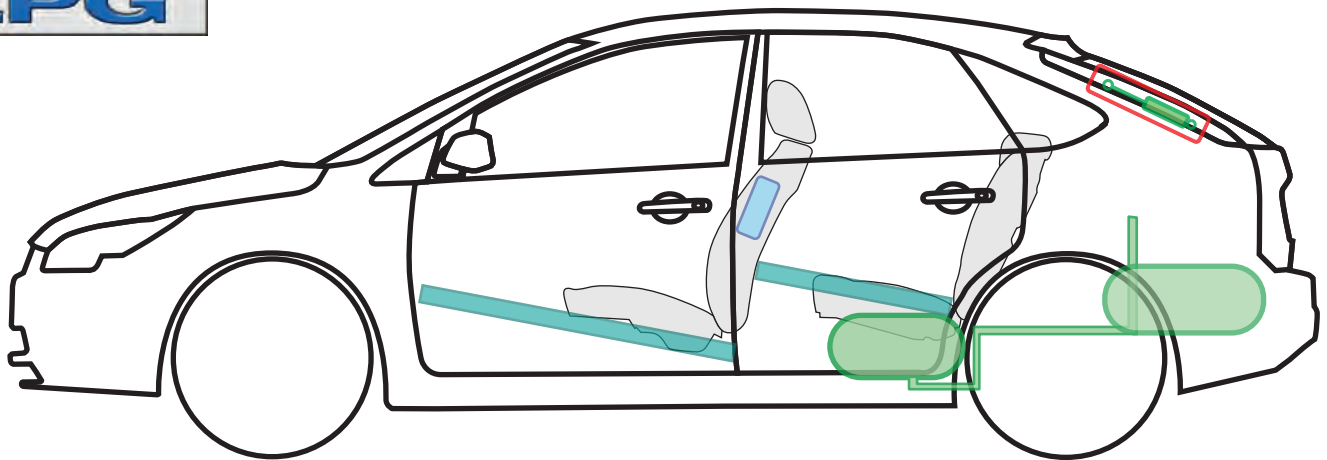

Legende

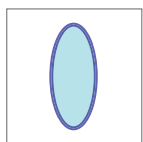

Airbag

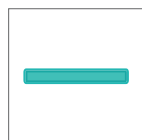

Karosserie-
verstärkung



Steuergerät



Gas-
generator



Überroll-
schutz

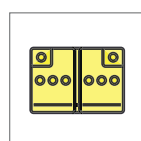

Batterie

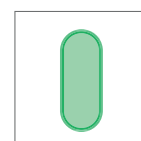

Gastank

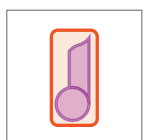

Gurt-
straffer



Gasdruck-
dämpfer

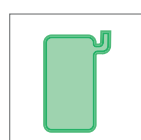

Kraftstoff-
tank

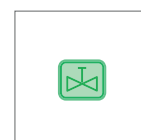

Sicherheits-
ventil

F



Ford Focus Turnier

07/2004 - 08/2007

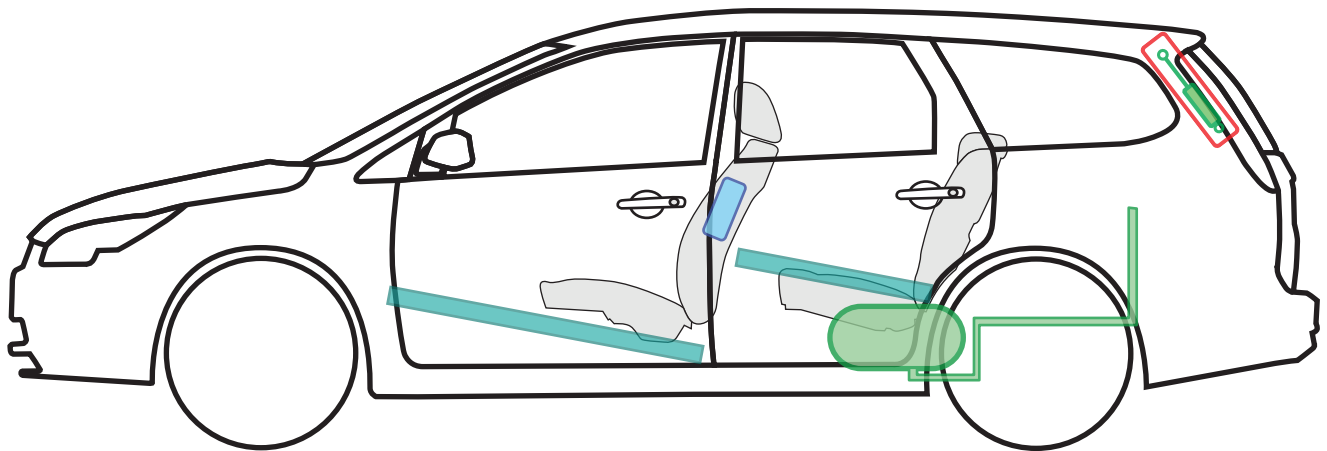
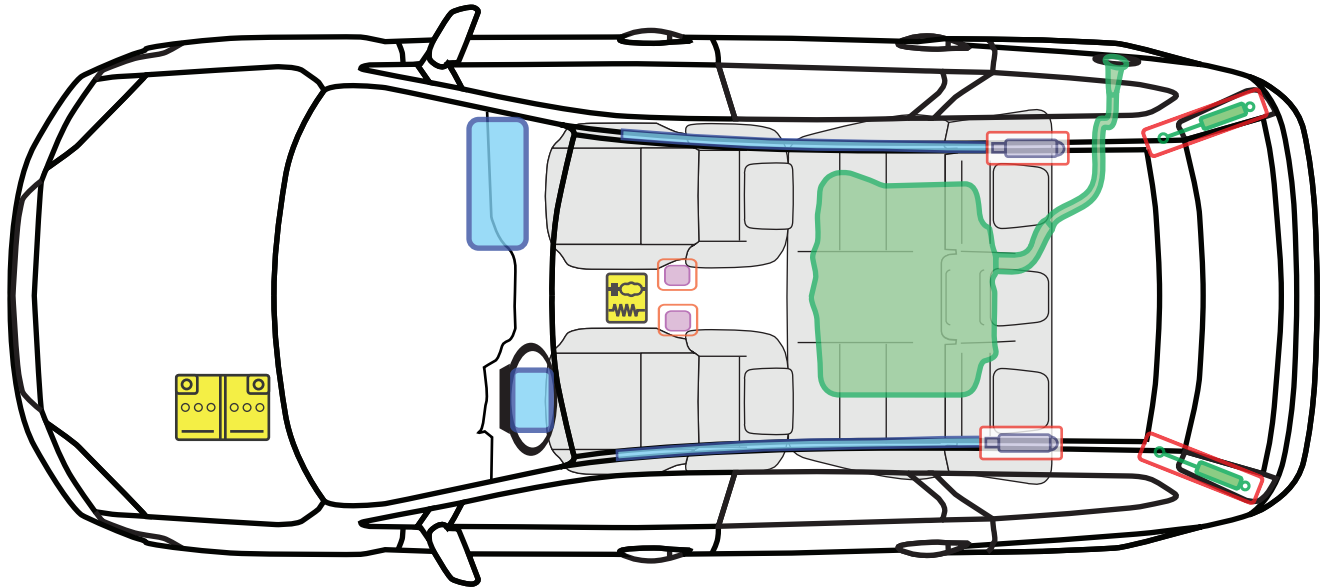

Legende

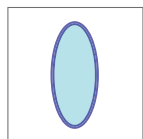

Airbag

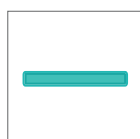

Karosserie-
verstärkung



Steuergerät



Gas-
generator



Überroll-
schutz

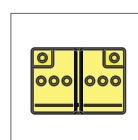

Batterie

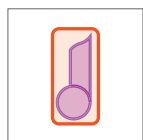

Gurt-
straffer



Gasdruck-
dämpfer

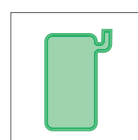

Kraftstoff-
tank

F



Ford Focus Turnier

07/2004 - 08/2007

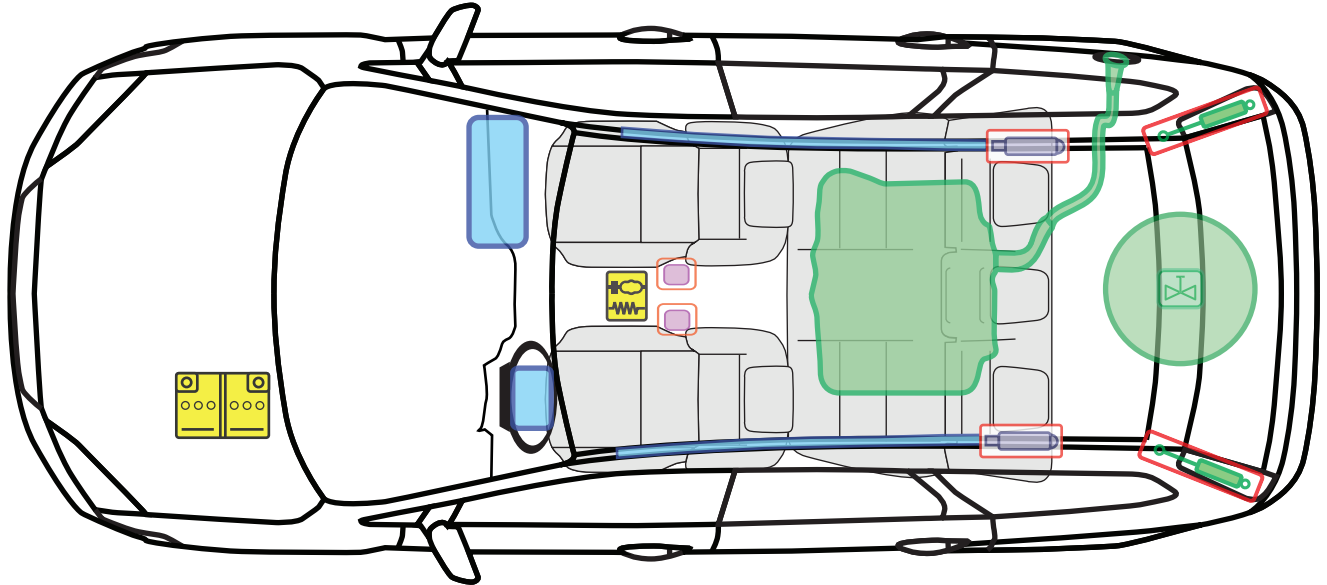

LPG

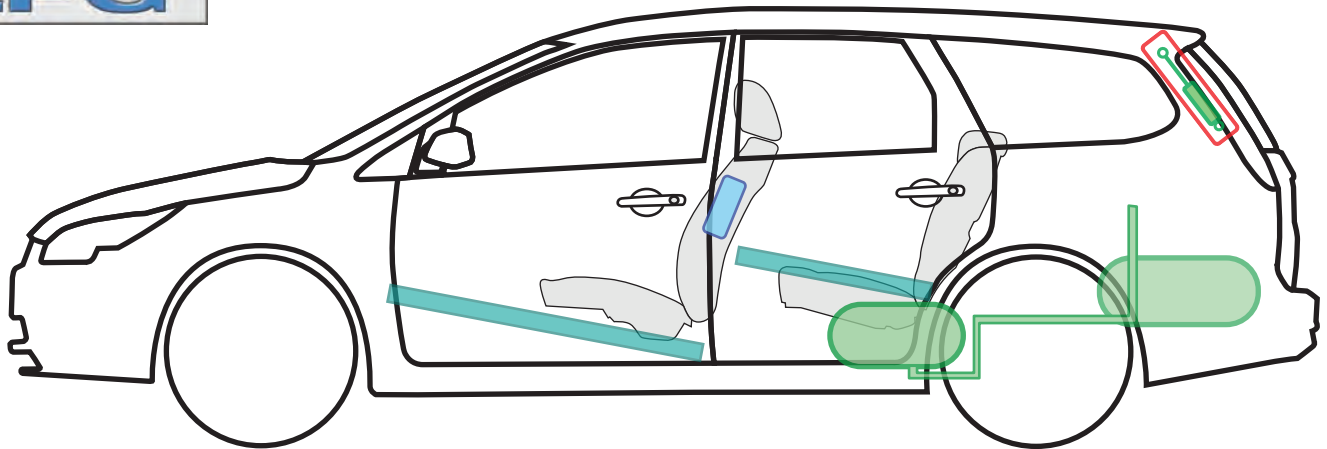

Legende

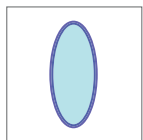

Airbag

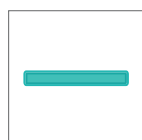

Karosserie-
verstärkung



Steuergerät



Gas-
generator



Überroll-
schutz

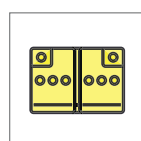

Batterie

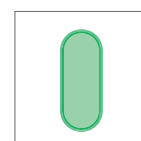

Gastank

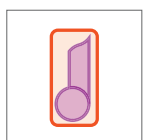

Gurt-
straffer



Gasdruck-
dämpfer

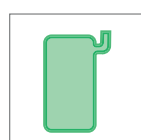

Kraftstoff-
tank

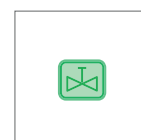

Sicherheits-
ventil

F



Ford Focus

3 Türer

08/2007 ->

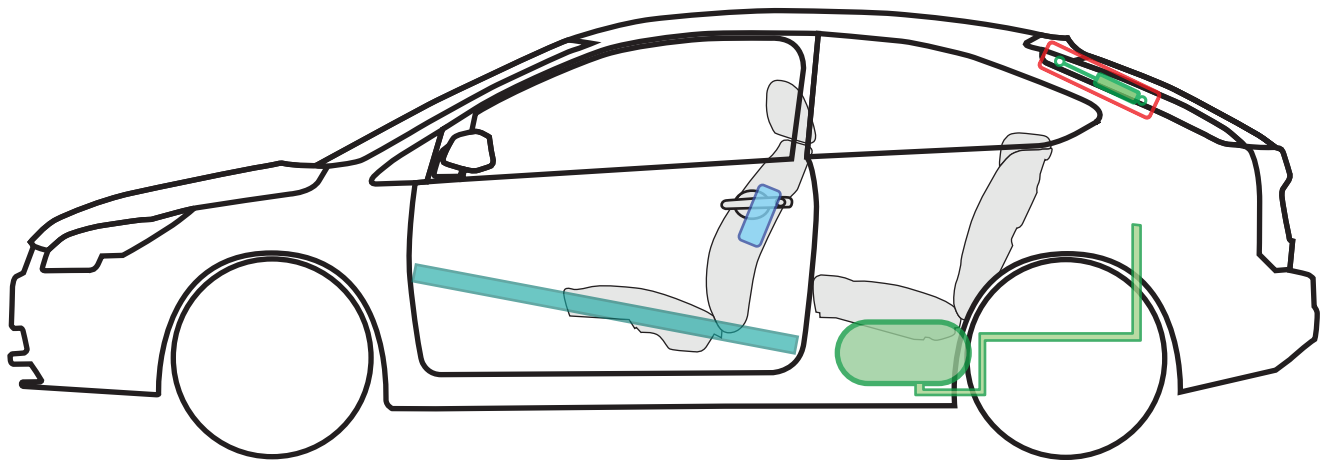
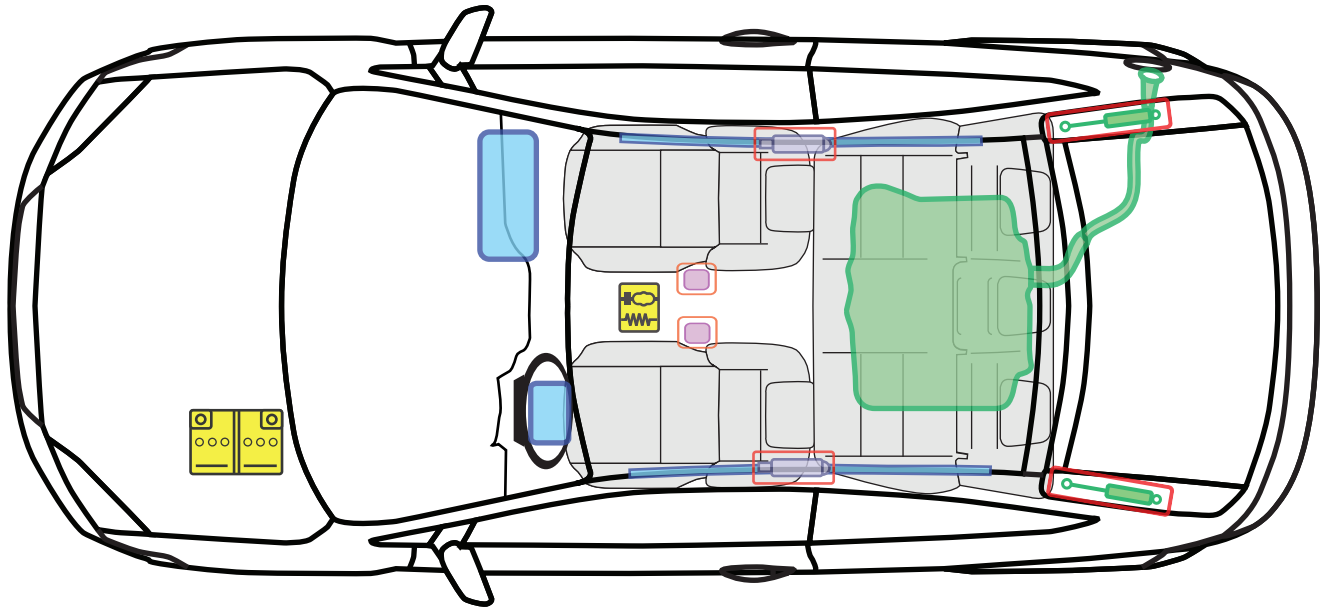

Legende

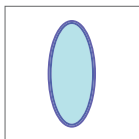

Airbag



Karosserie-
verstärkung



Steuergerät



Gas-
generator



Überroll-
schutz

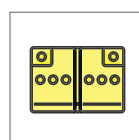

Batterie

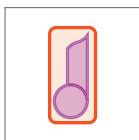

Gurt-
straffer



Gasdruck-
dämpfer

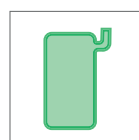

Kraftstoff-
tank





Ford Focus 3 Türer

08/2007 ->

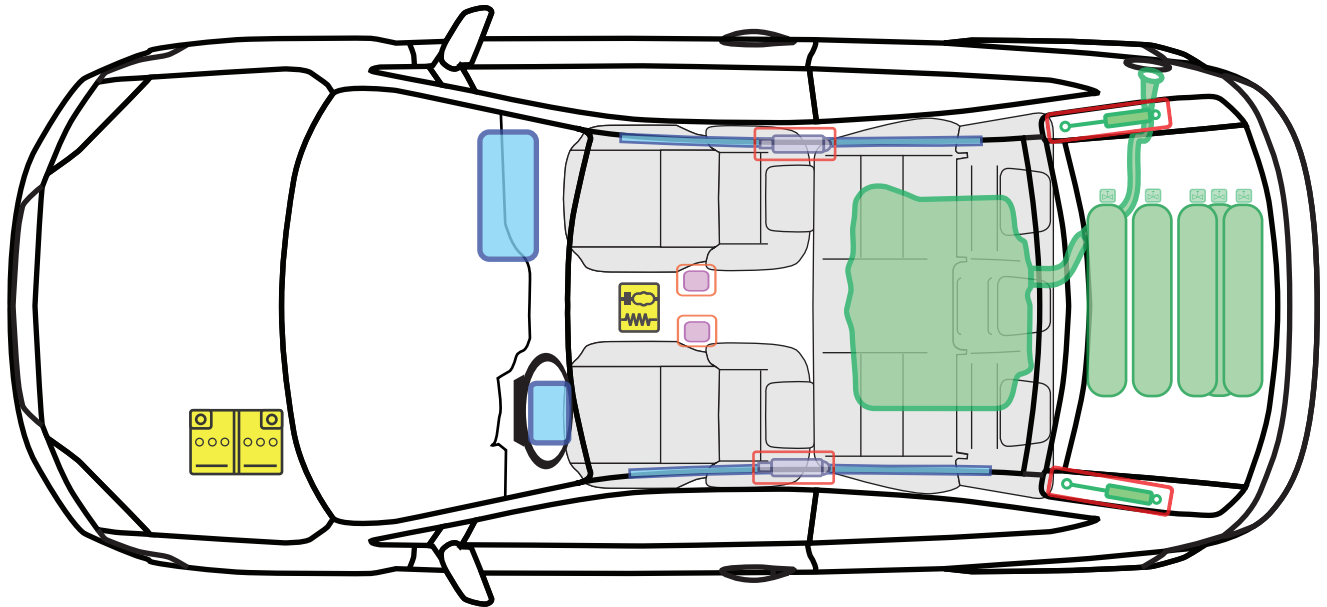

CNG

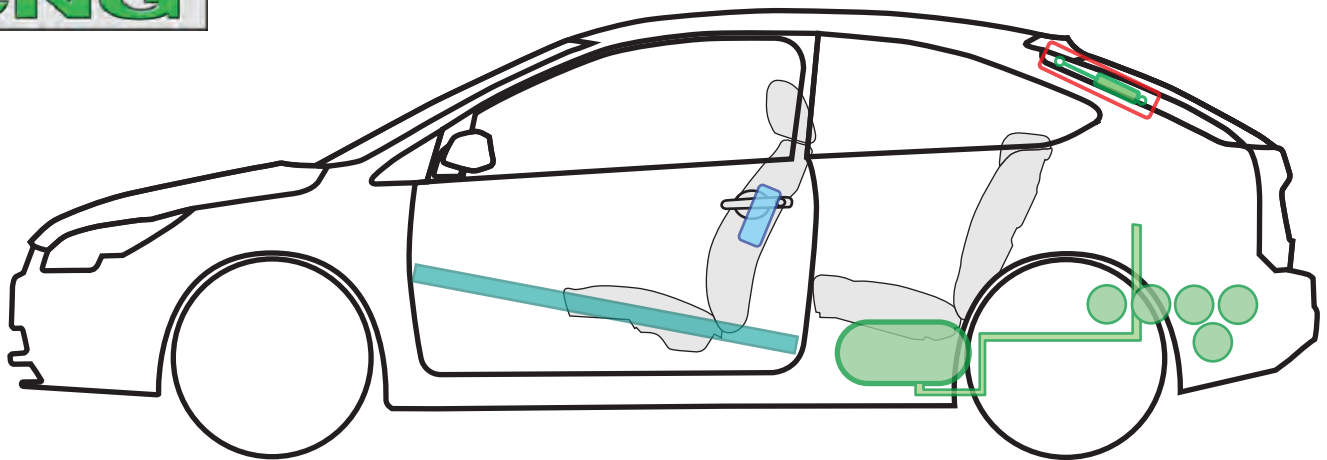

Legende

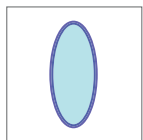

Airbag

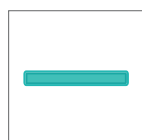

Karosserie-
verstärkung



Steuergerät



Gas-
generator



Überroll-
schutz

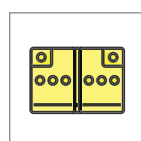

Batterie

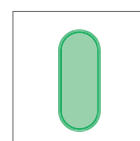

Gastank

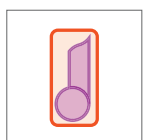

Gurt-
straffer



Gasdruck-
dämpfer

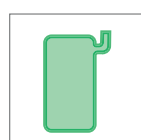

Kraftstoff-
tank

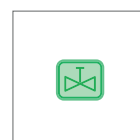

Sicherheits-
ventil

F



Ford Focus 3 Türer

08/2007 ->

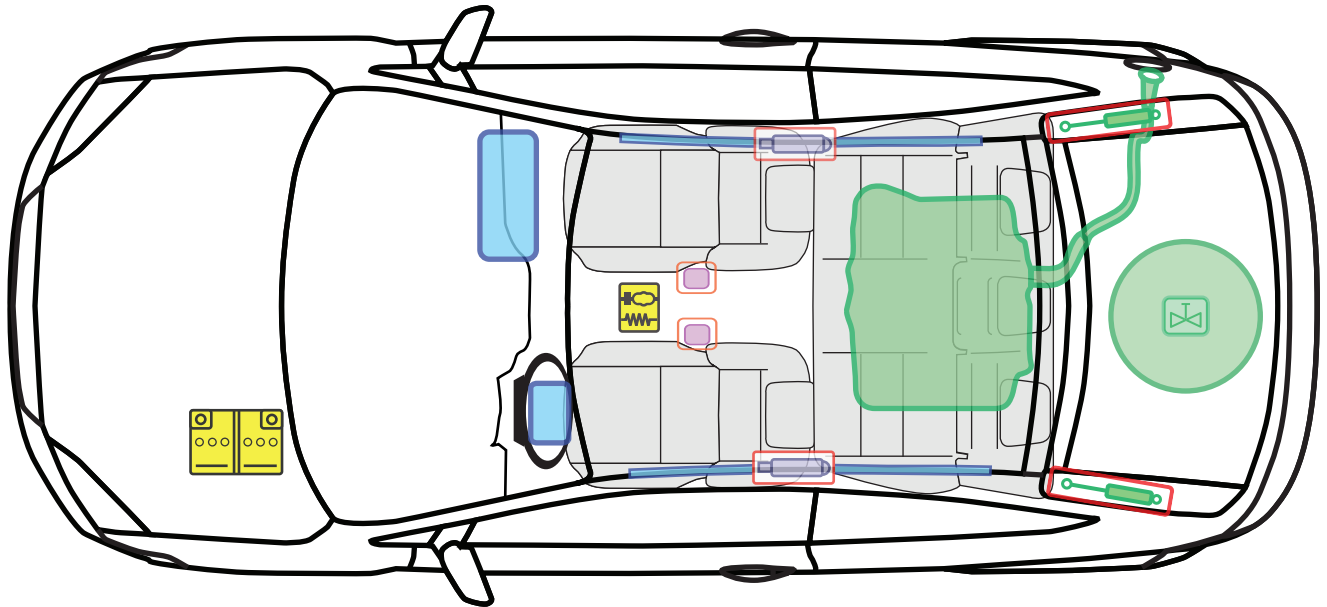

LPG

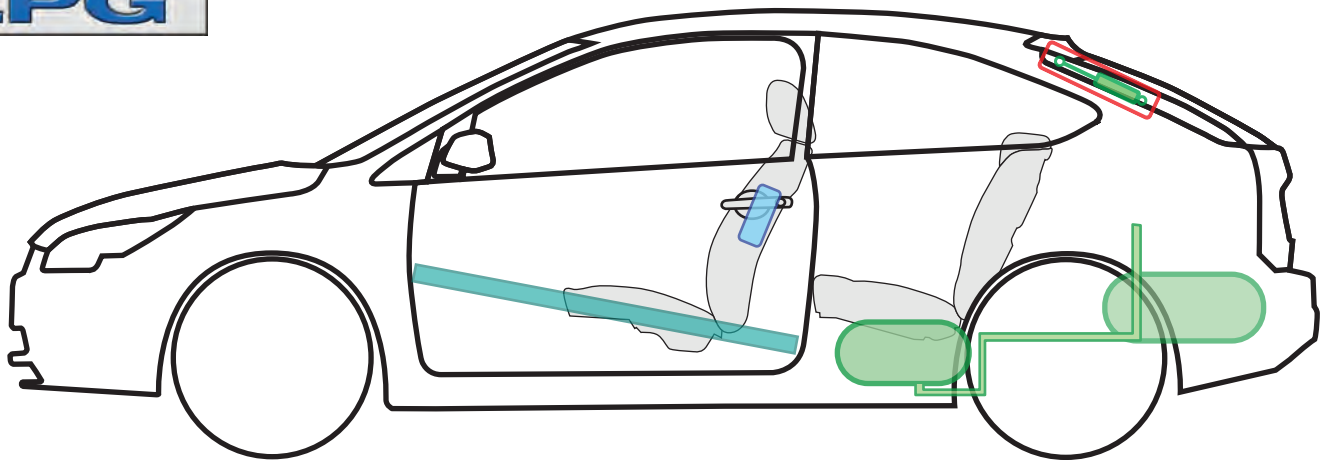

Legende

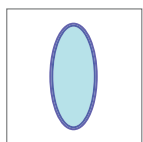

Airbag

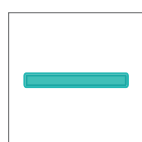

Karosserie-
verstärkung



Steuergerät



Gas-
generator



Überroll-
schutz

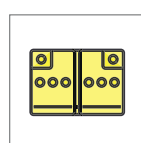

Batterie

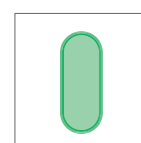

Gastank

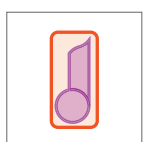

Gurt-
straffer



Gasdruck-
dämpfer



Kraftstoff-
tank

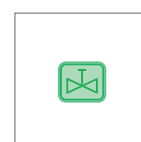

Sicherheits-
ventil

F



Ford Focus

4 Tüer

08/2007->

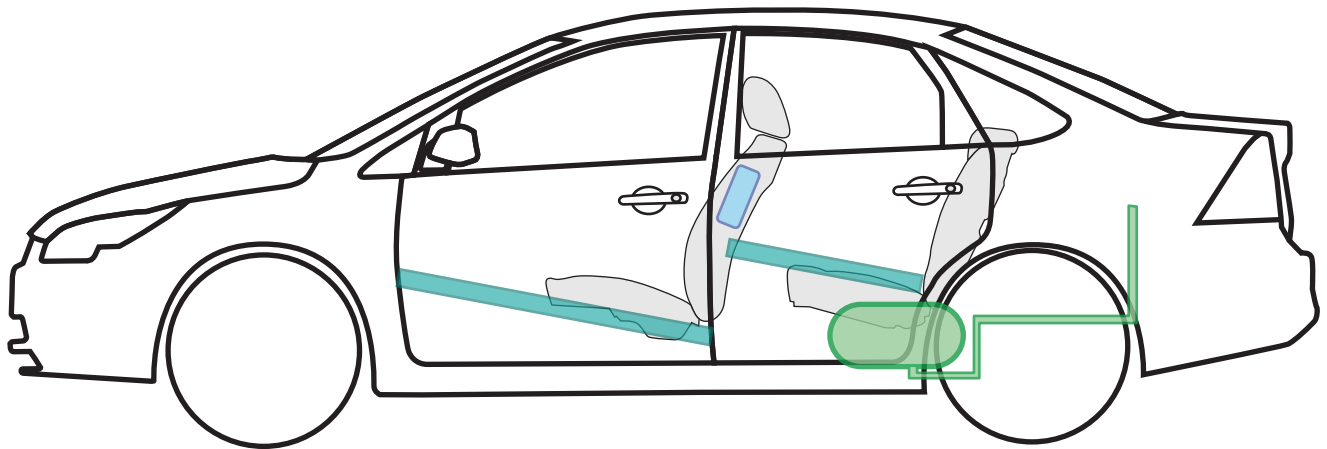
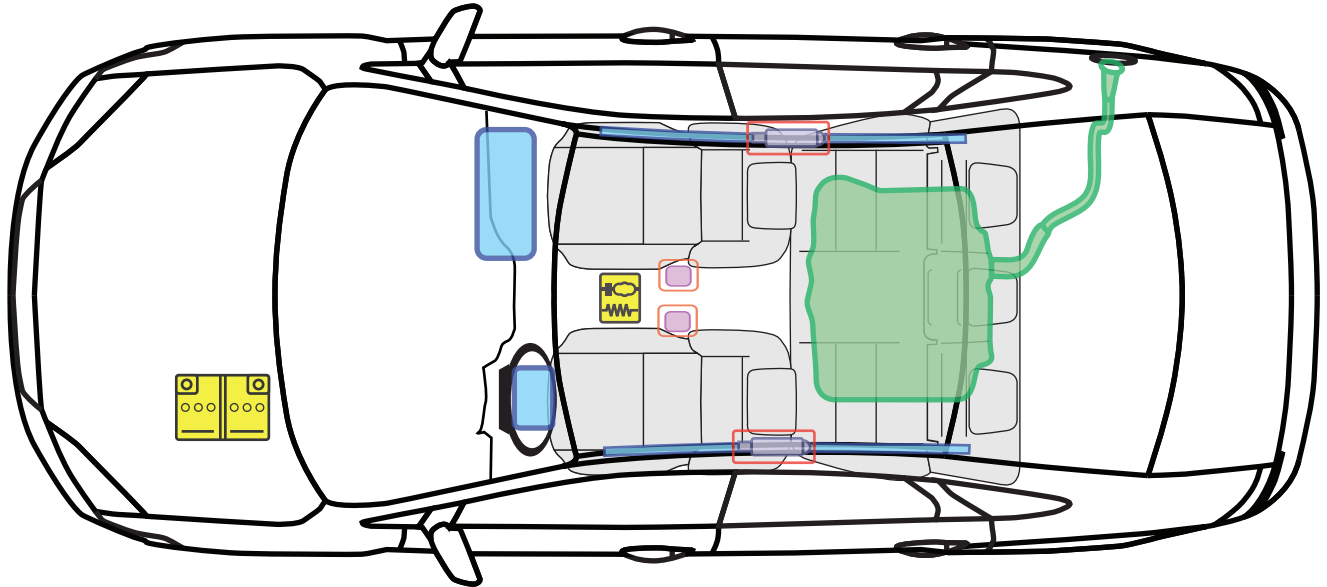

Legende

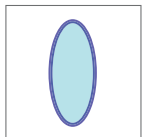

Airbag

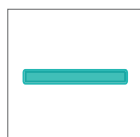

Karosserie-
verstärkung



Steuergerät



Gas-
generator



Überroll-
schutz

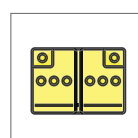

Batterie

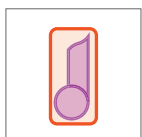

Gurt-
straffer



Gasdruck-
dämpfer

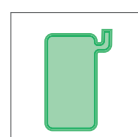

Kraftstoff-
tank

F



Ford Focus

5 Tüer

08/2007->

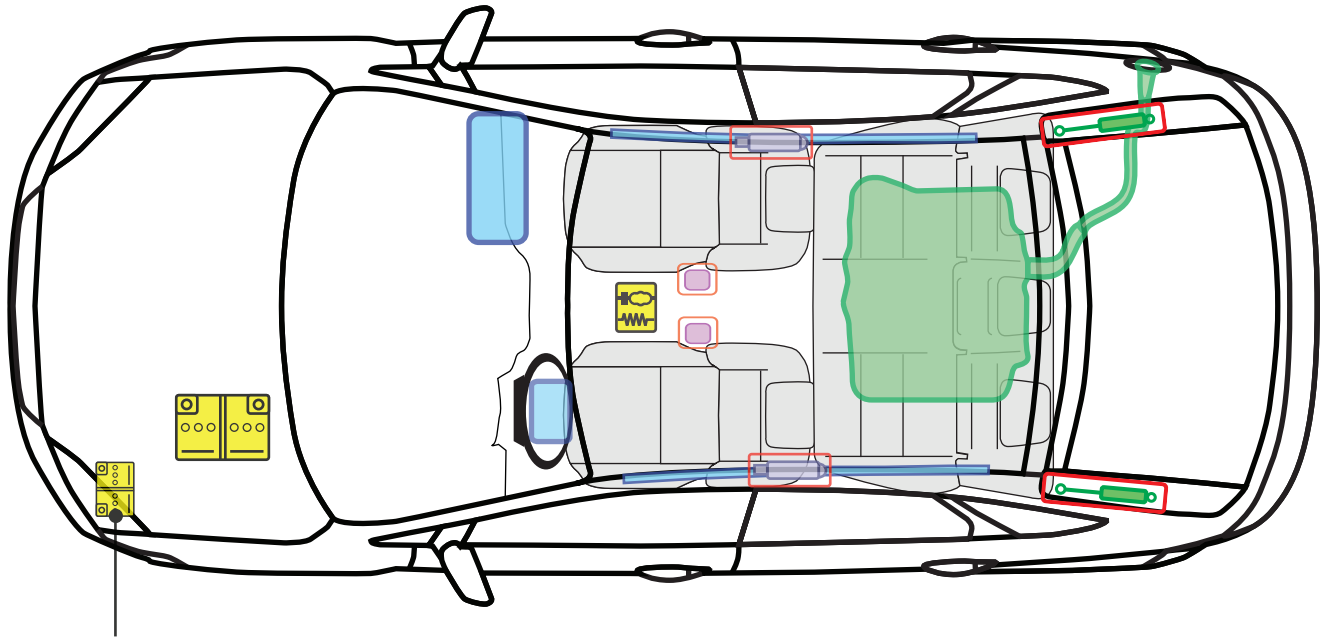

2. Batterie nur für Fahrzeuge mit Start / Stop Automatik

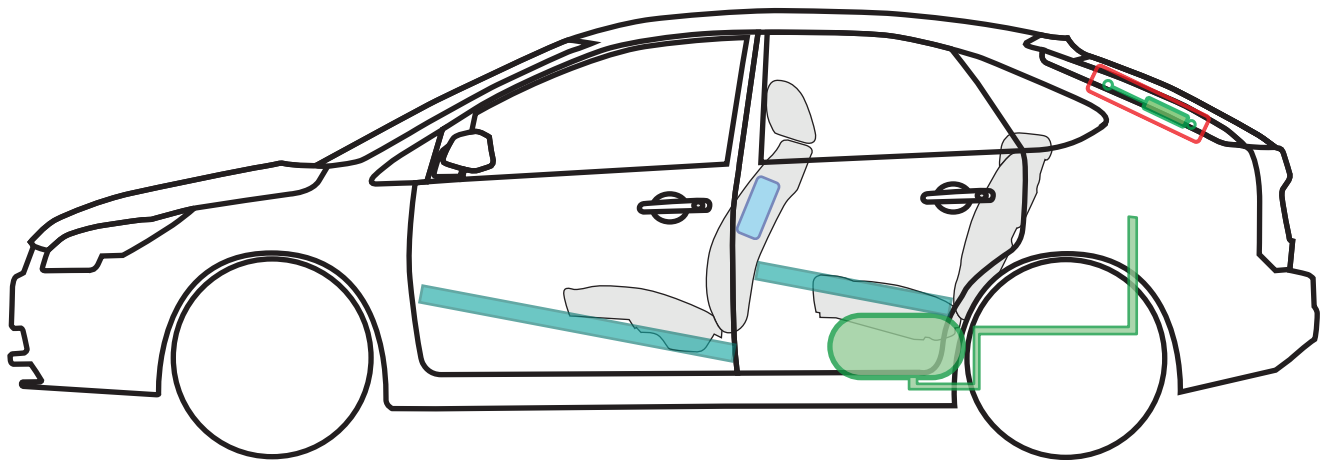

Legende

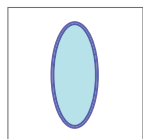

Airbag



Karosserie-
verstärkung



Steuergerät



Gas-
generator



Überroll-
schutz

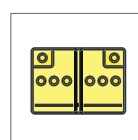

Batterie

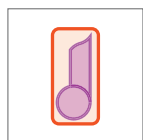

Gurt-
straffer



Gasdruck-
dämpfer

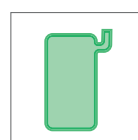

Kraftstoff-
tank

F



Ford Focus

5 Tüer

08/2007->

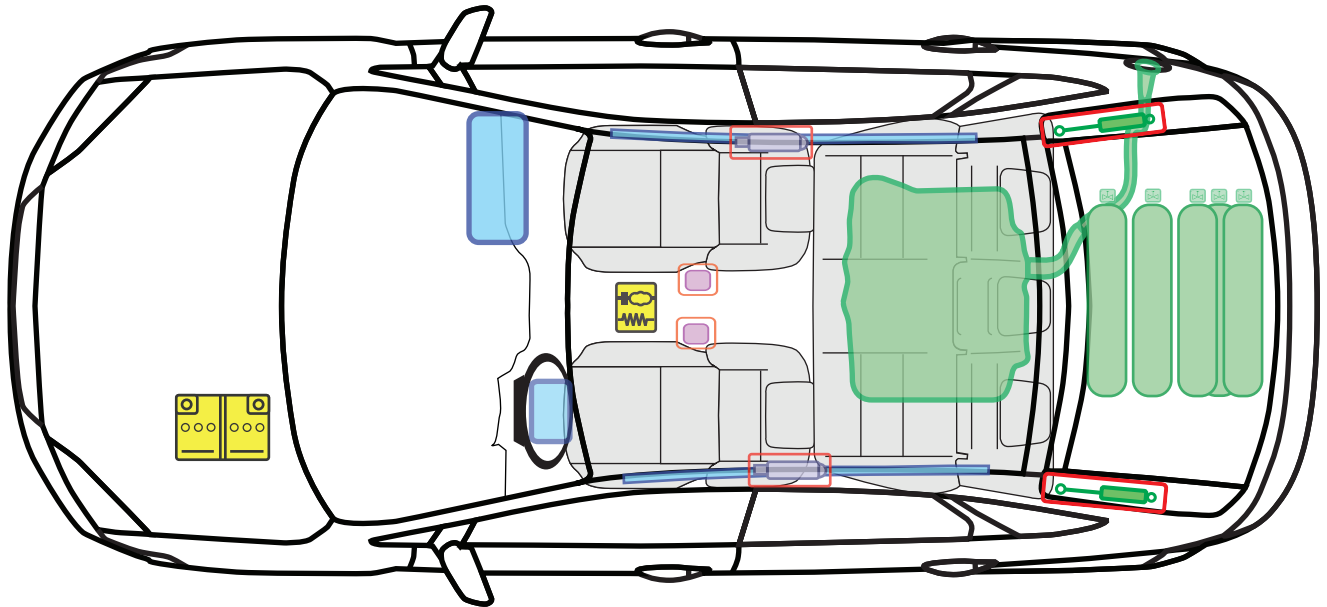

CNG

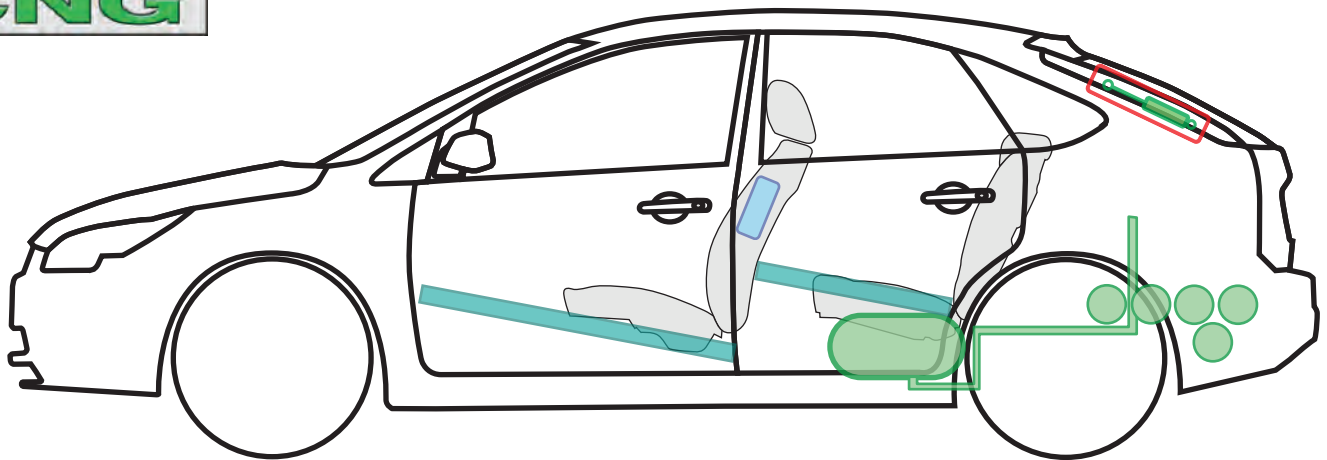

Legende

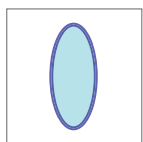

Airbag

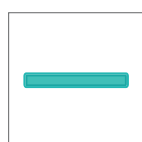

Karosserie-
verstärkung



Steuergerät



Gas-
generator



Überroll-
schutz

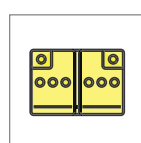

Batterie

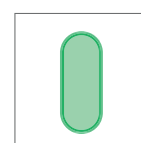

Gastank

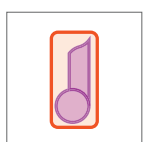

Gurt-
straffer

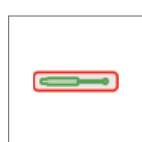

Gasdruck-
dämpfer



Kraftstoff-
tank

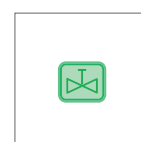

Sicherheits-
ventil

F



Ford Focus

5 Tüer

08/2007->

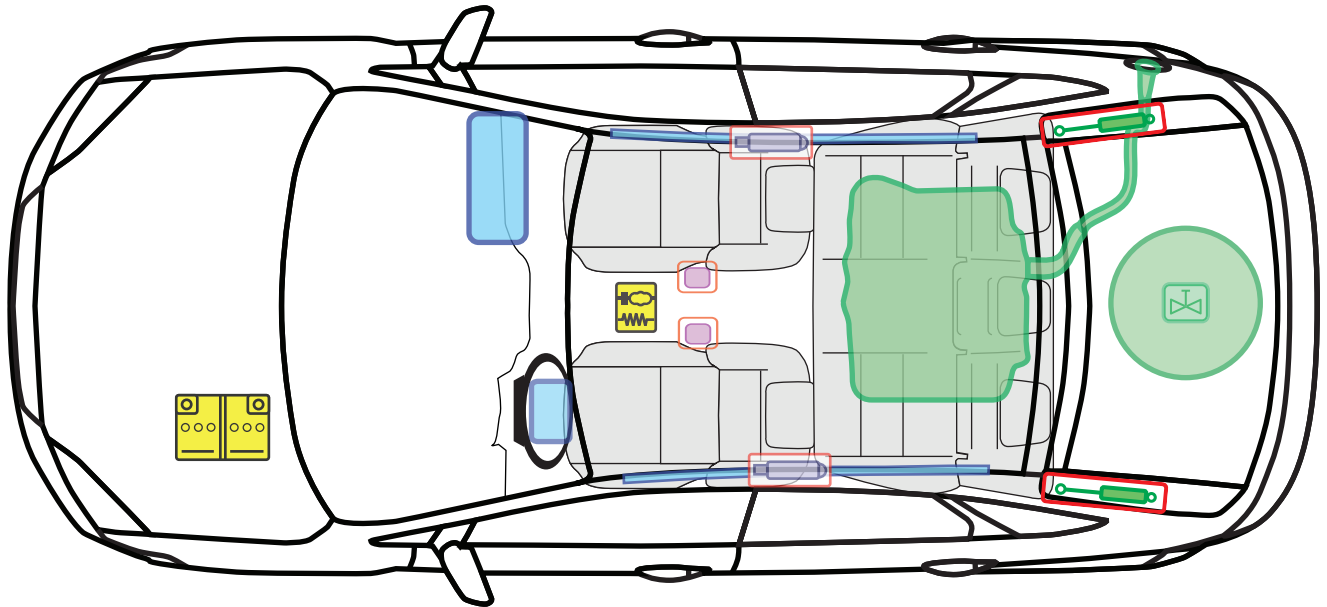

LPG

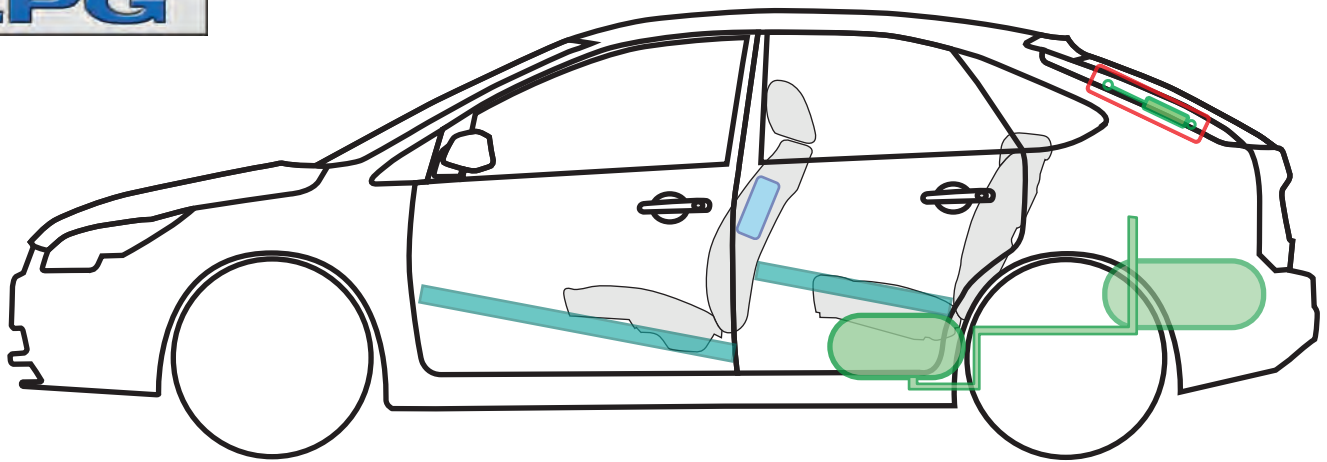

Legende

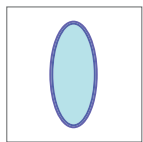

Airbag

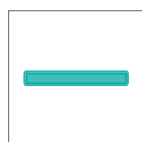

Karosserie-
verstärkung



Steuergerät



Gas-
generator



Überroll-
schutz

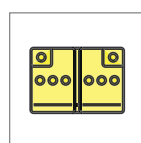

Batterie

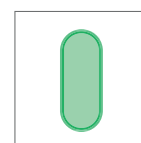

Gastank

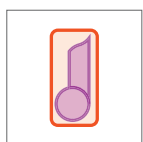

Gurt-
straffer



Gasdruck-
dämpfer

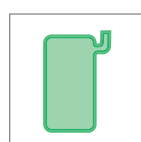

Kraftstoff-
tank

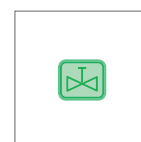

Sicherheits-
ventil

F



Ford Focus Turnier

08/2007 ->

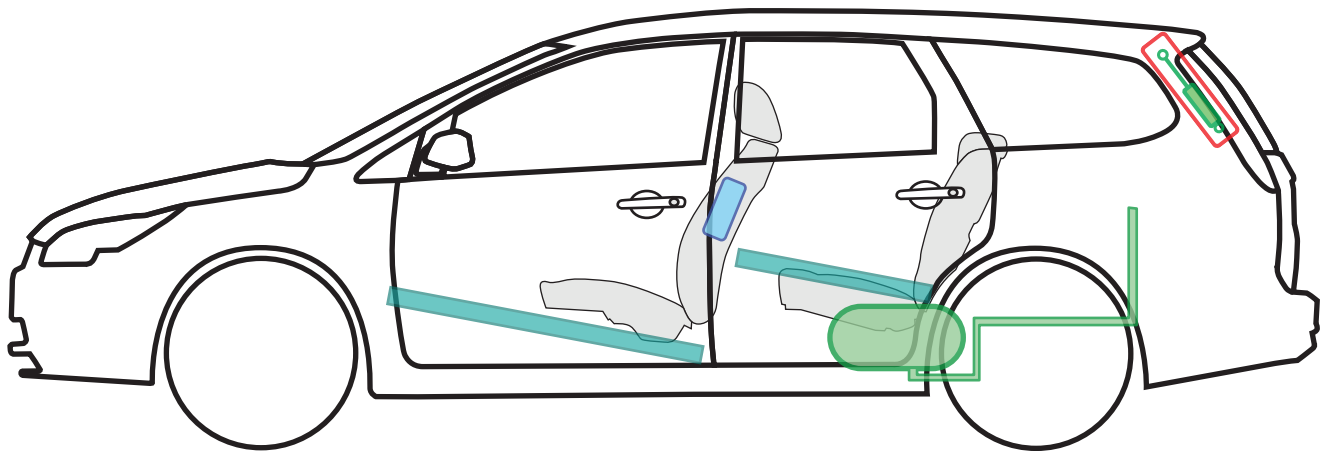
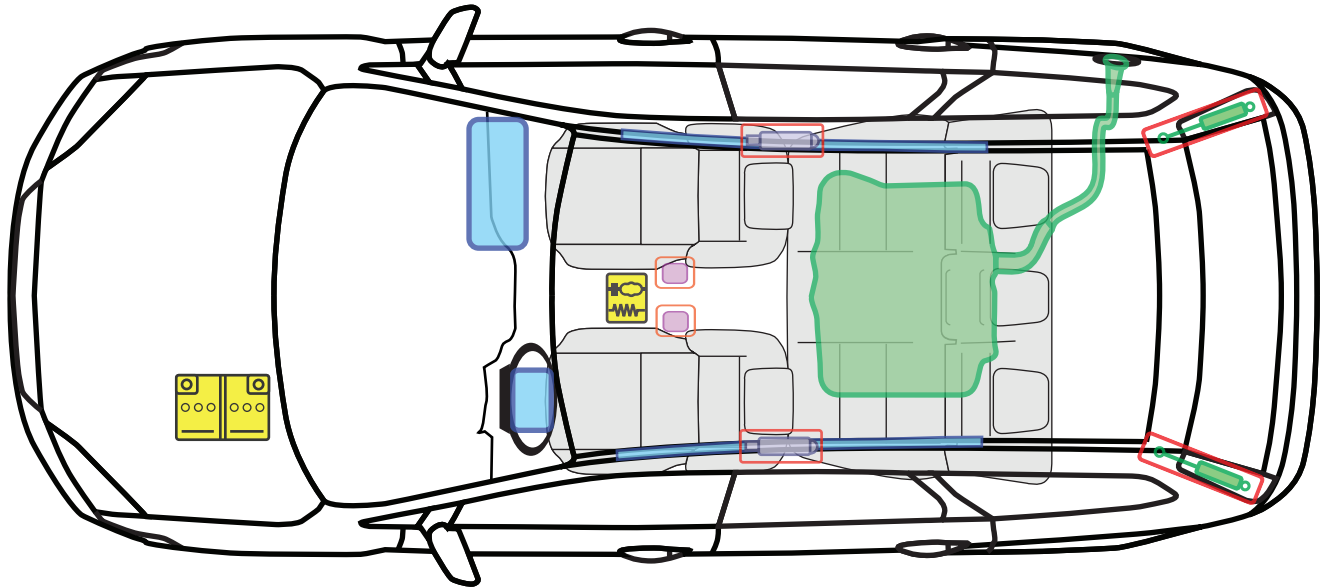

Legende

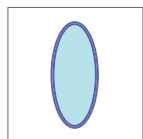

Airbag

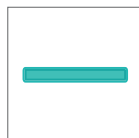

Karosserie-
verstärkung



Steuergerät



Gas-
generator



Überroll-
schutz

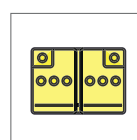

Batterie

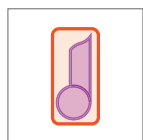

Gurt-
straffer



Gasdruck-
dämpfer

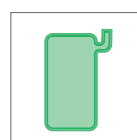

Kraftstoff-
tank

F



Ford Focus Turnier

08/2007 ->

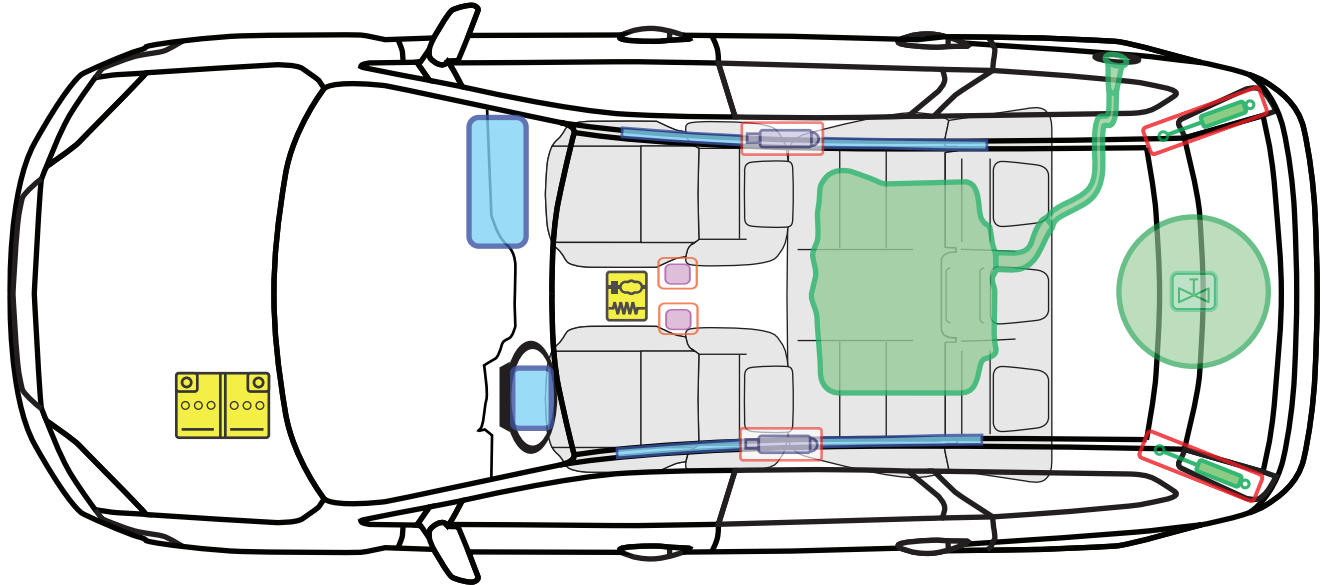

LPG

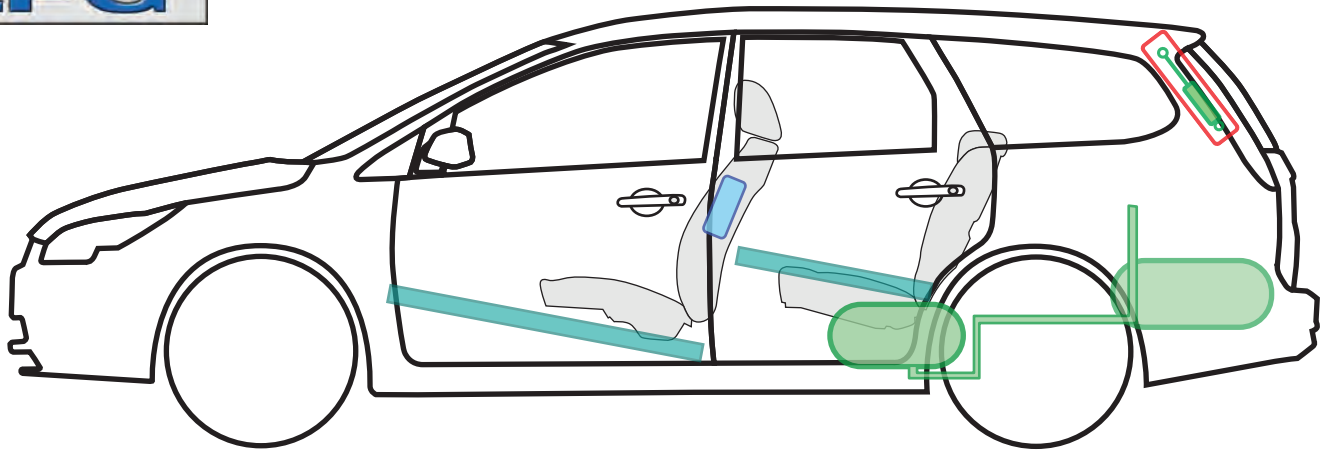

Legende

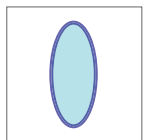

Airbag

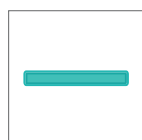

Karosserie-
verstärkung



Steuergerät



Gas-
generator



Überroll-
schutz

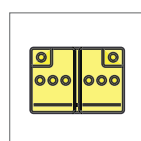

Batterie

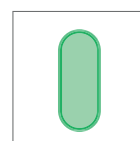

Gastank

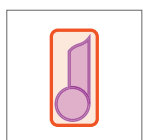

Gurt-
straffer



Gasdruck-
dämpfer

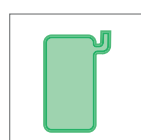

Kraftstoff-
tank

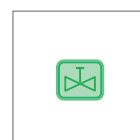

Sicherheits-
ventil

F



Ford Fusion

06/2002 ->

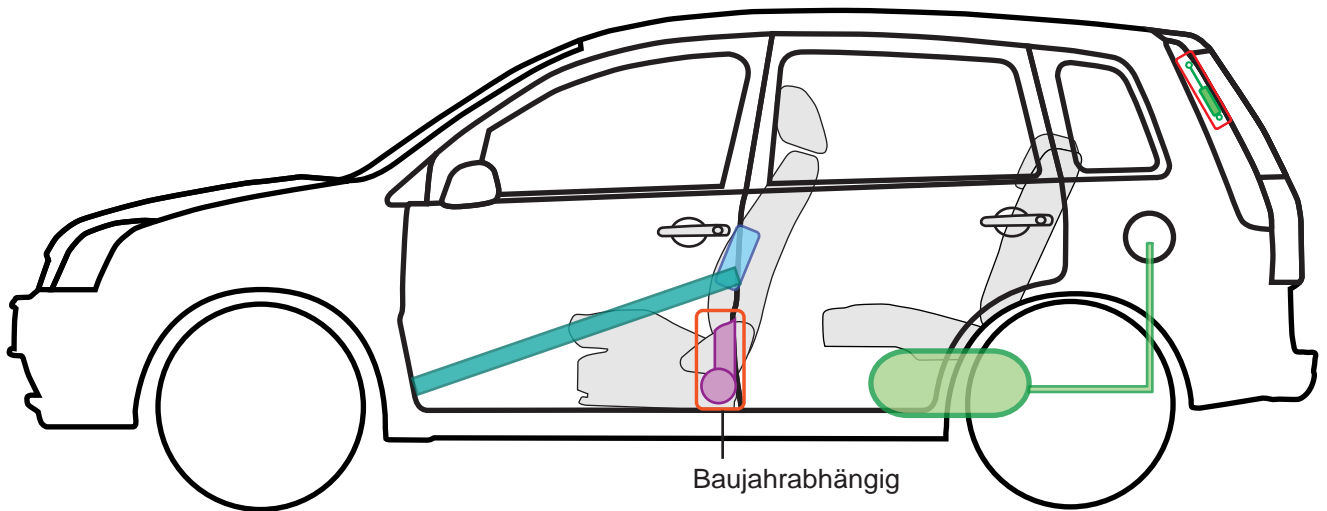
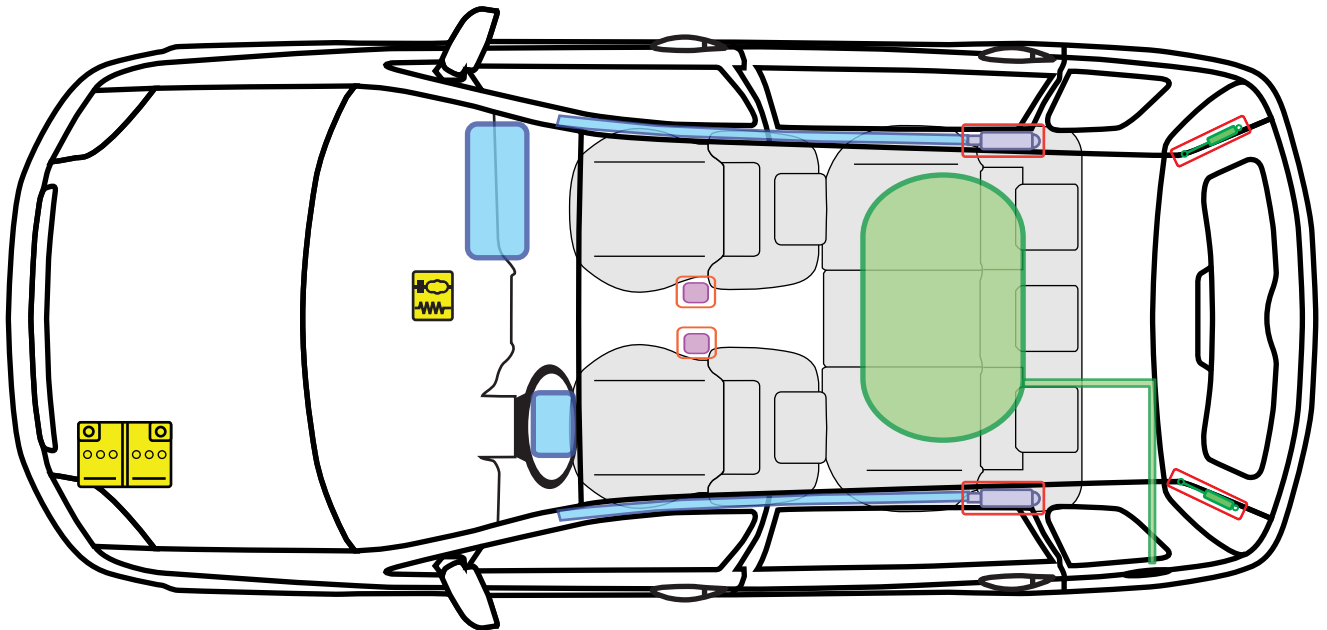

Baujahrabhängig

Legende

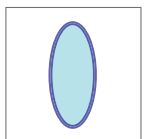

Airbag

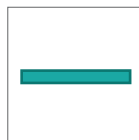

Karosserie-
verstärkung



Steuergerät

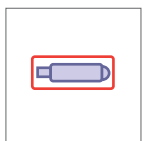

Gas-
generator

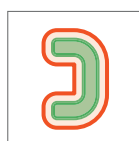

Überroll-
schutz

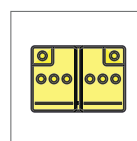

Batterie

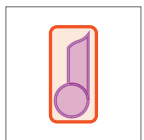

Gurt-
straffer

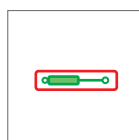

Gasdruck-
dämpfer

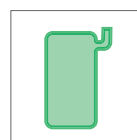

Kraftstoff-
tank

F



Ford Galaxy

04/2000 - 02/2006

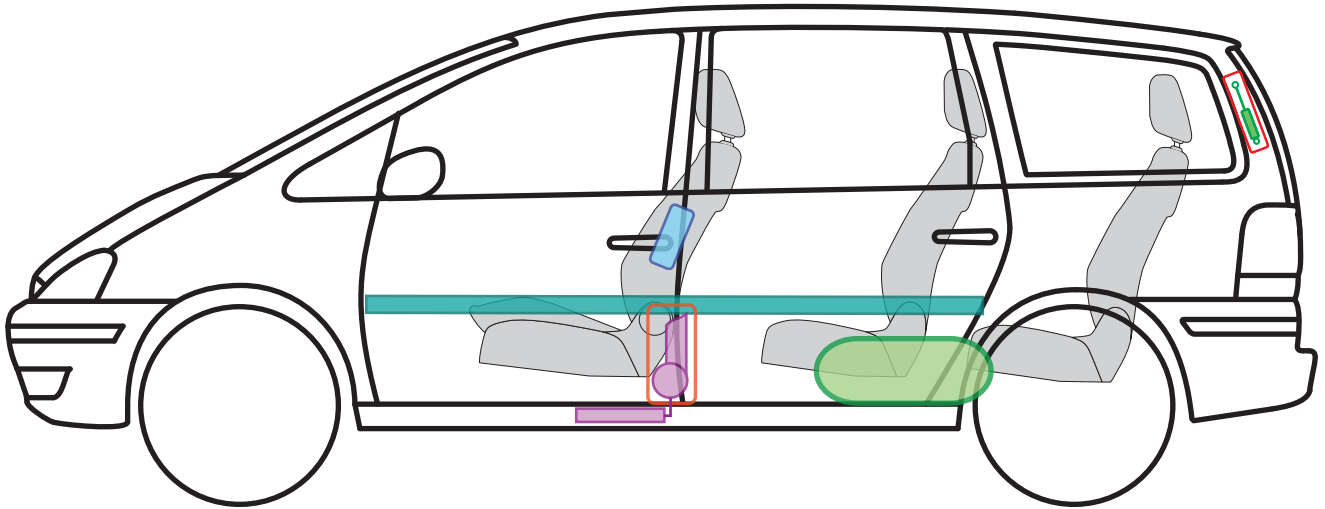
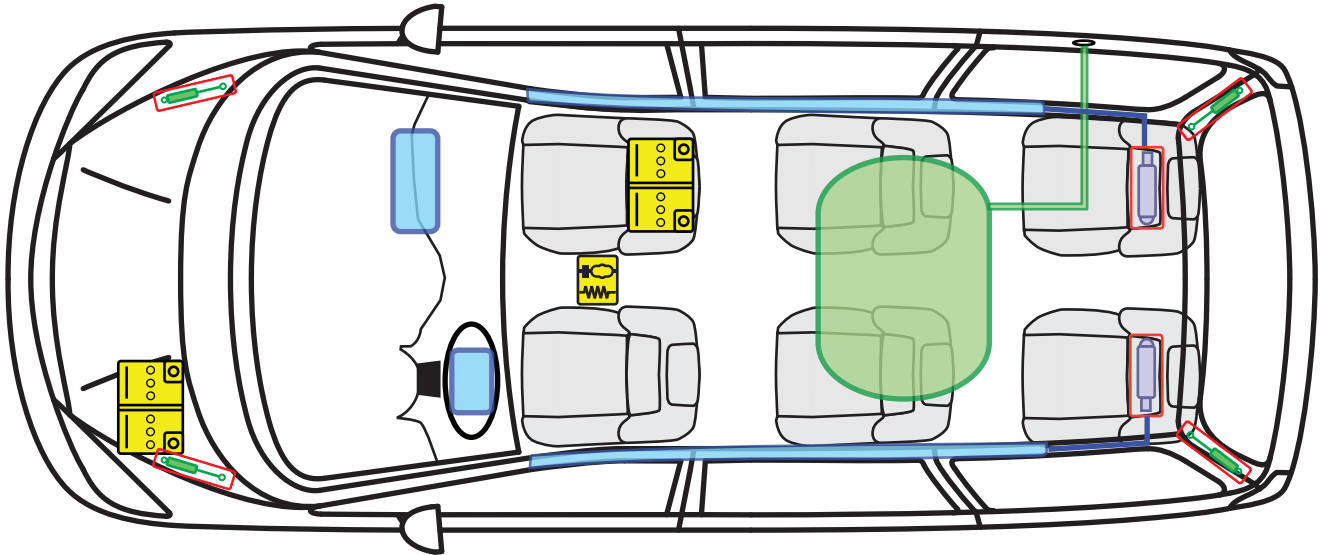

Legende

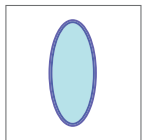

Airbag

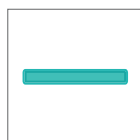

Karosserie-
verstärkung



Steuergerät



Gas-
generator



Überroll-
schutz

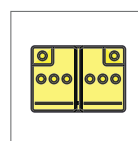

Batterie

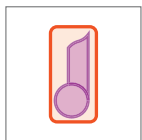

Gurt-
straffer

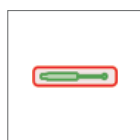

Gasdruck-
dämpfer

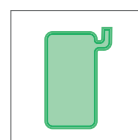

Kraftstoff-
tank





Ford Galaxy

02/2006 ->

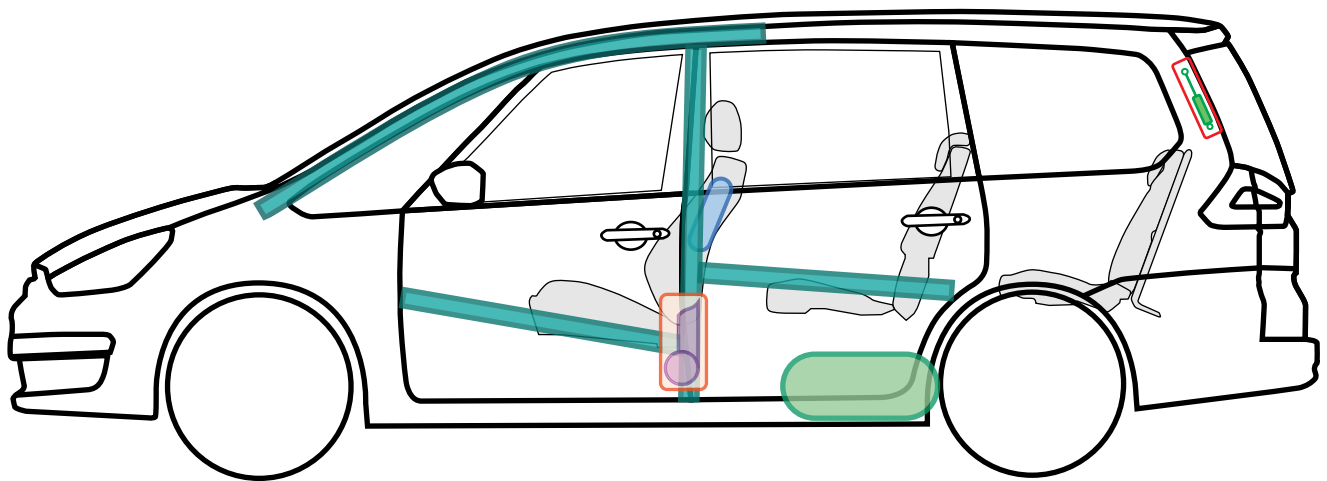
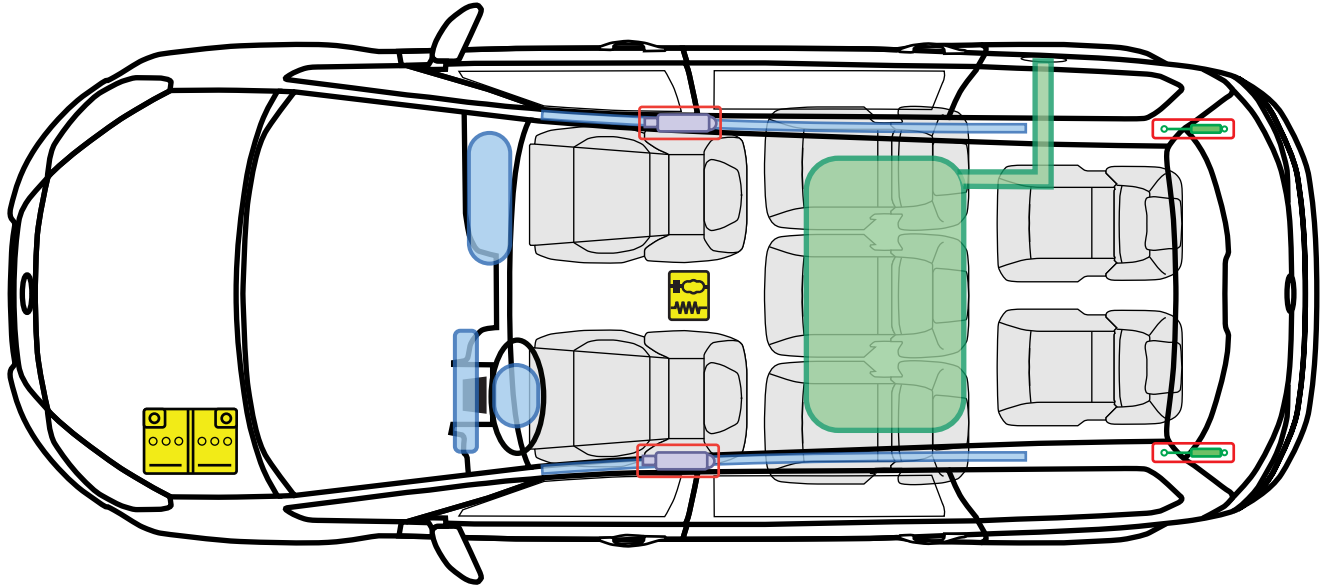

Legende

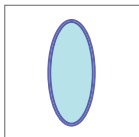

Airbag

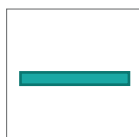

Karosserie-
verstärkung



Steuergerät

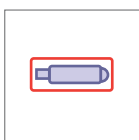

Gas-
generator



Überroll-
schutz

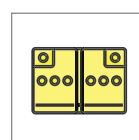

Batterie

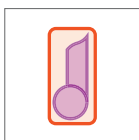

Gurt-
straffer

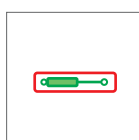

Gasdruck-
dämpfer

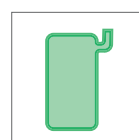

Kraftstoff-
tank





Ford KA

09/1996 - 07/2008

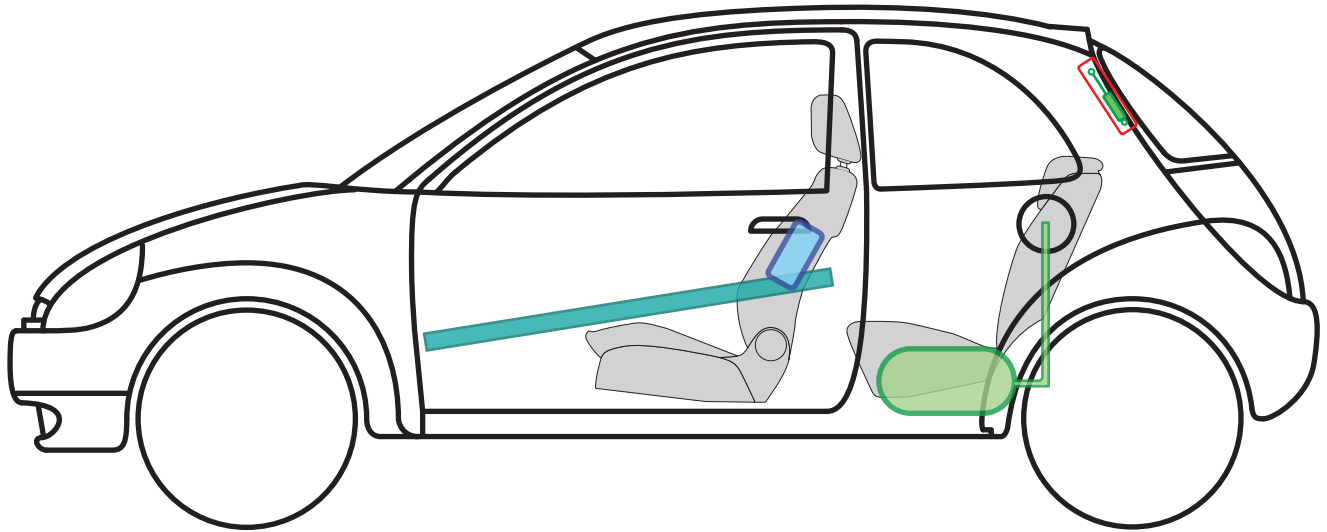
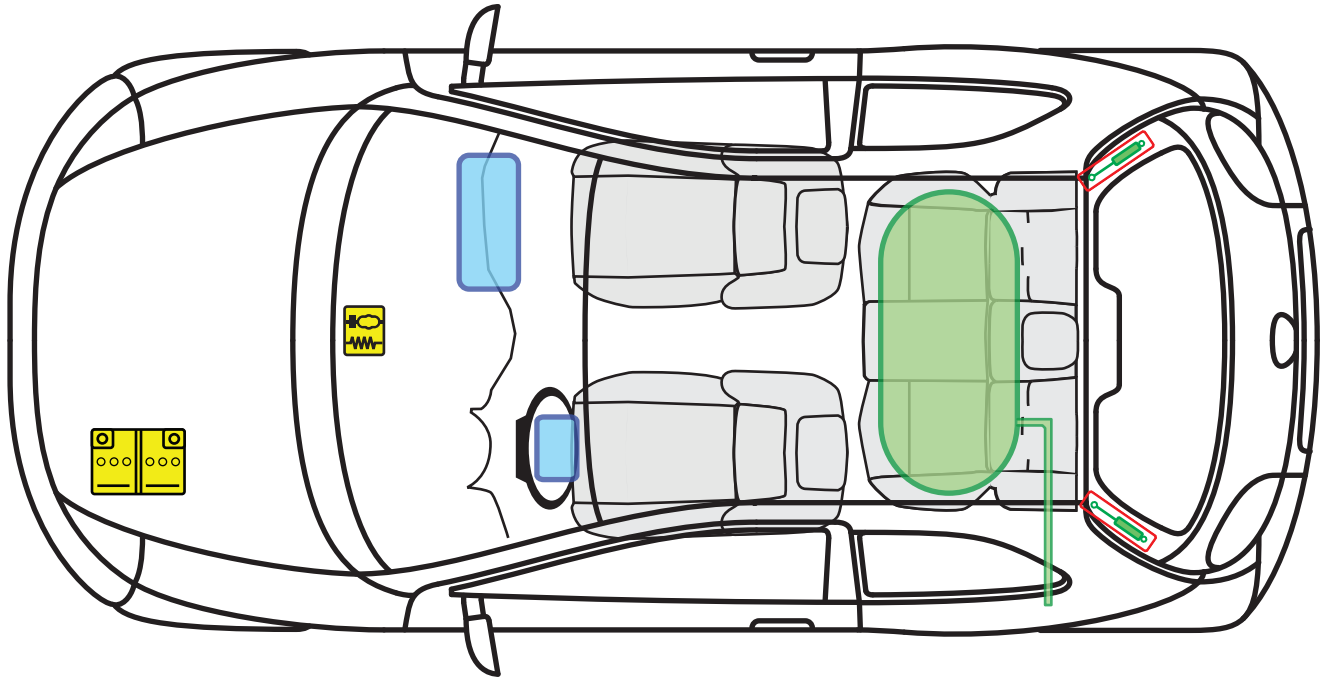

Legende

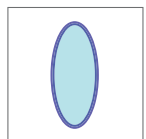

Airbag

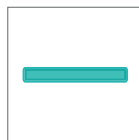

Karosserie-
verstärkung



Steuergerät



Gas-
generator

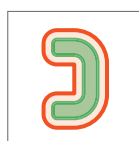

Überroll-
schutz

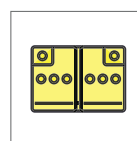

Batterie

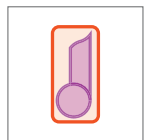

Gurt-
straffer



Gasdruck-
dämpfer

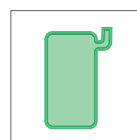

Kraftstoff-
tank





Ford Ka

08/2008 ->

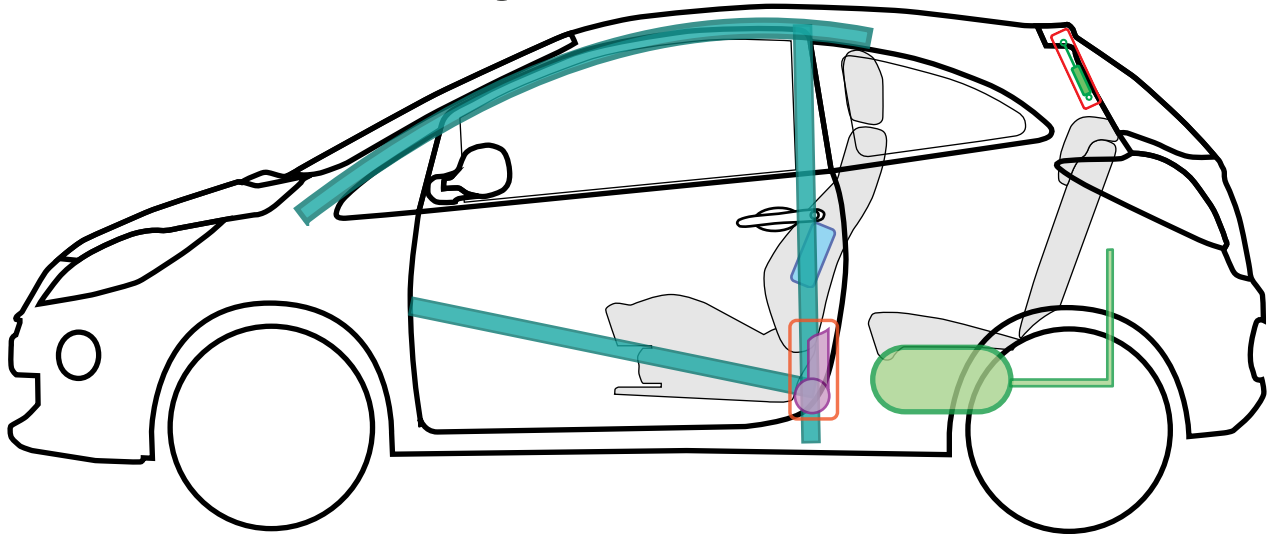
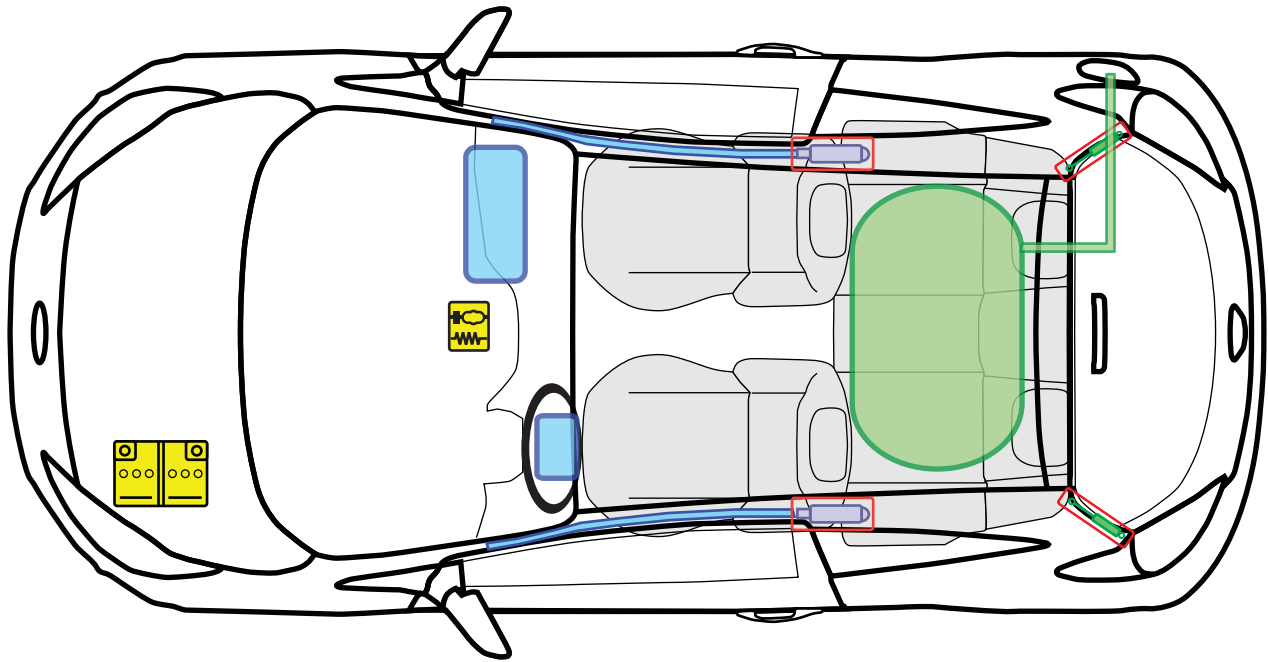

Legende

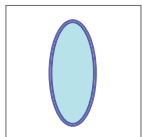

Airbag

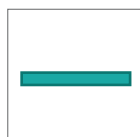

Karosserie-
verstärkung



Steuergerät

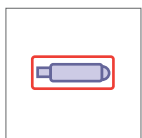

Gas-
generator



Überroll-
schutz

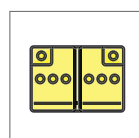

Batterie

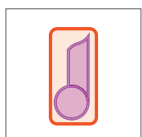

Gurt-
straffer

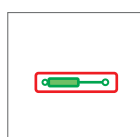

Gasdruck-
dämpfer



Kraftstoff-
tank





Ford Kuga

02/2008 ->

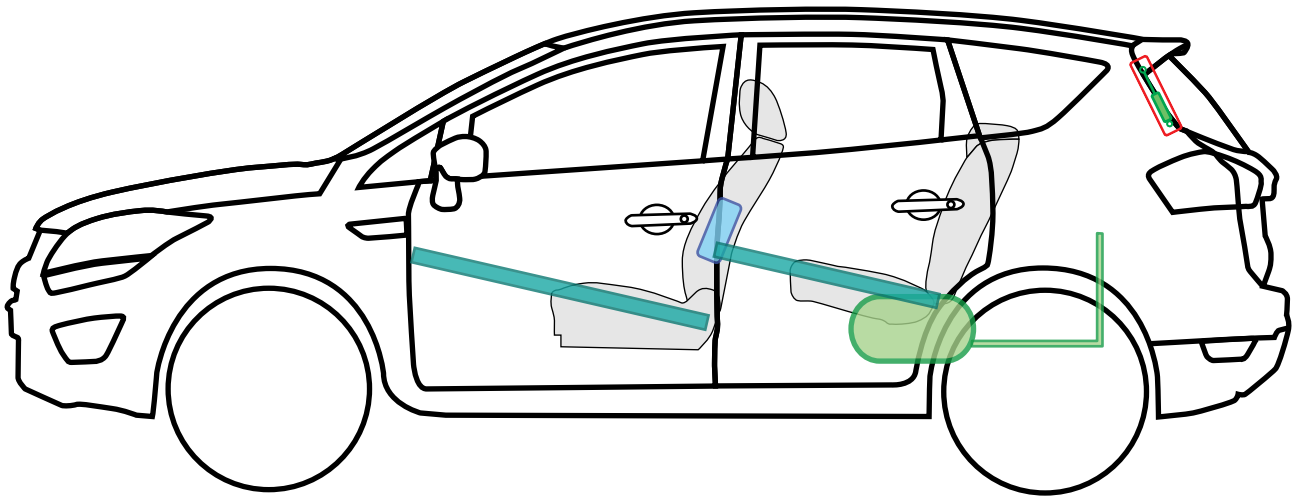
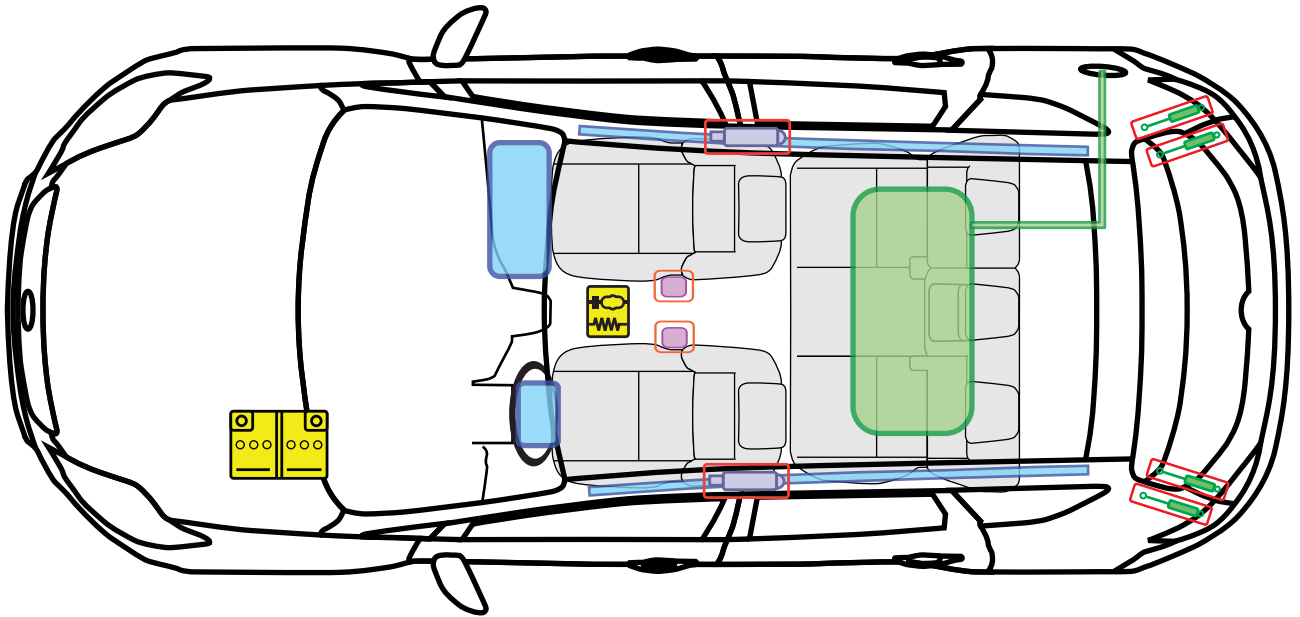

Legende

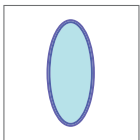

Airbag



Karosserie-
verstärkung



Steuergerät

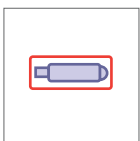

Gas-
generator



Überroll-
schutz

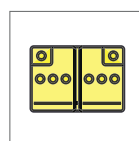

Batterie

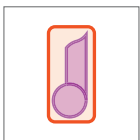

Gurt-
straffer

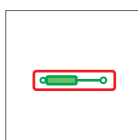

Gasdruck-
dämpfer

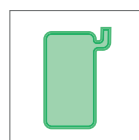

Kraftstoff-
tank

K



Ford Mondeo 4 Tüer

10/2000 - 02/2007

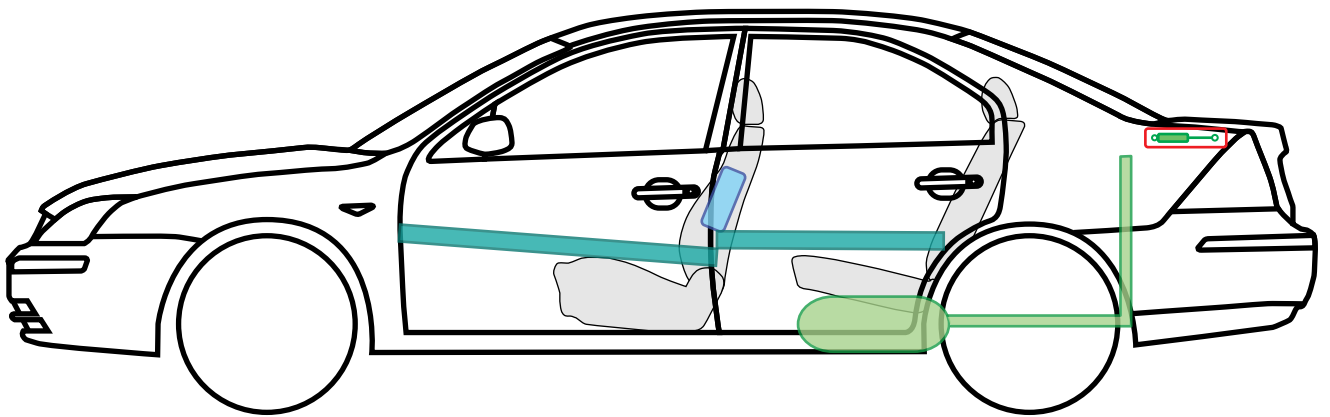
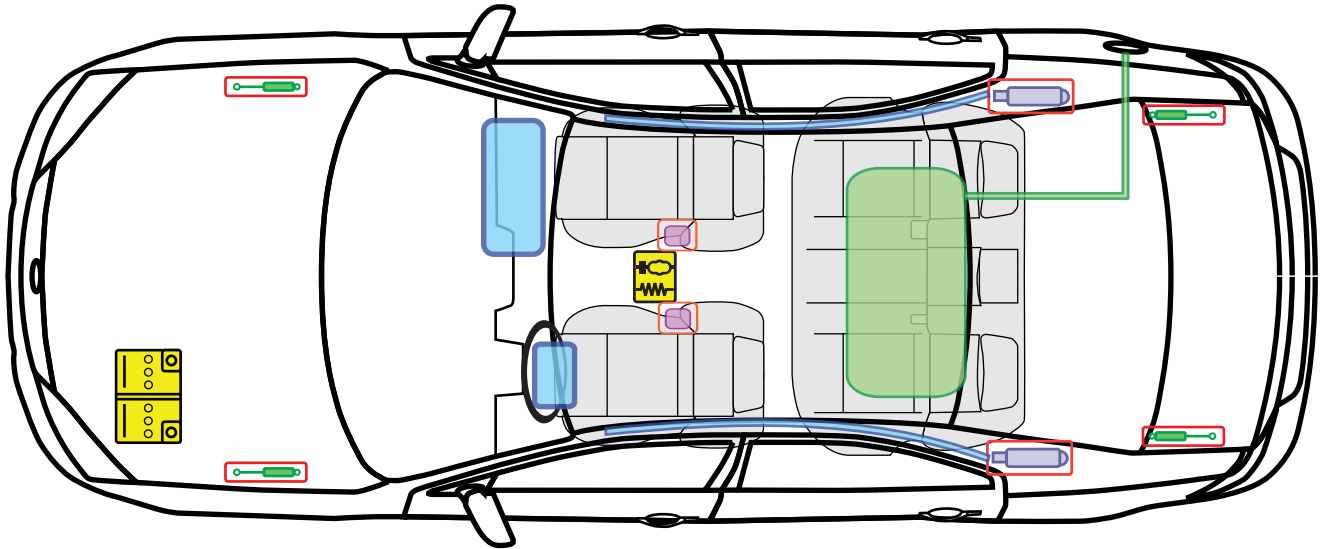

Legende

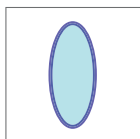

Airbag

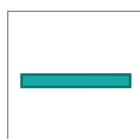

Karosserie-
verstärkung

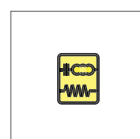

Steuergerät

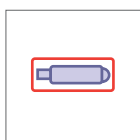

Gas-
generator



Überroll-
schutz

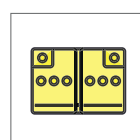

Batterie

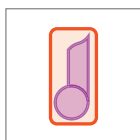

Gurt-
straffer

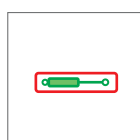

Gasdruck-
dämpfer



Kraftstoff-
tank





Ford Mondeo

5 Tüer

10/2000 - 02/2007

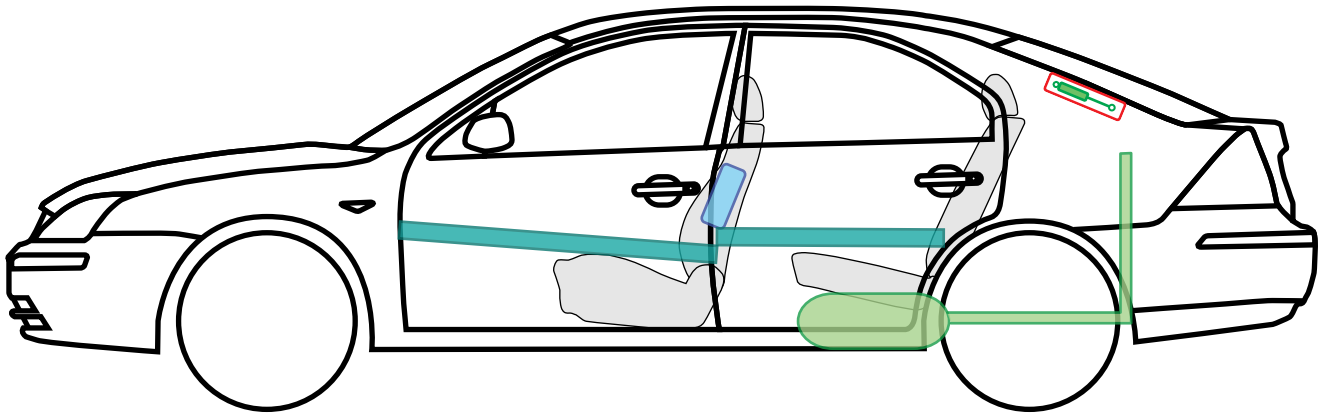
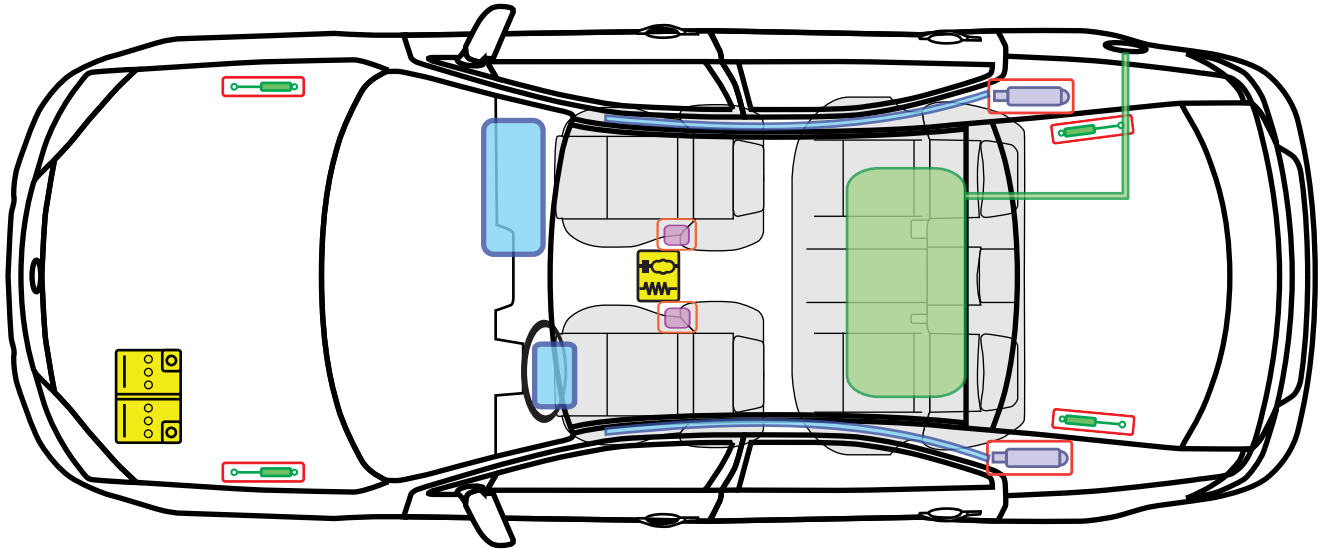

Legende

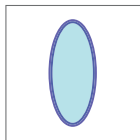

Airbag

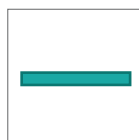

Karosserie-
verstärkung



Steuergerät

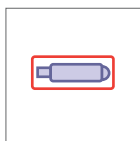

Gas-
generator

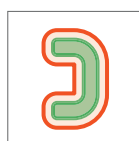

Überroll-
schutz

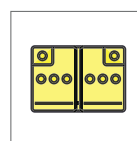

Batterie

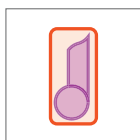

Gurt-
straffer

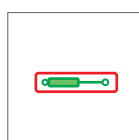

Gasdruck-
dämpfer

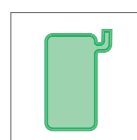

Kraftstoff-
tank





Ford Mondeo Turnier

10/2000 - 02/2007

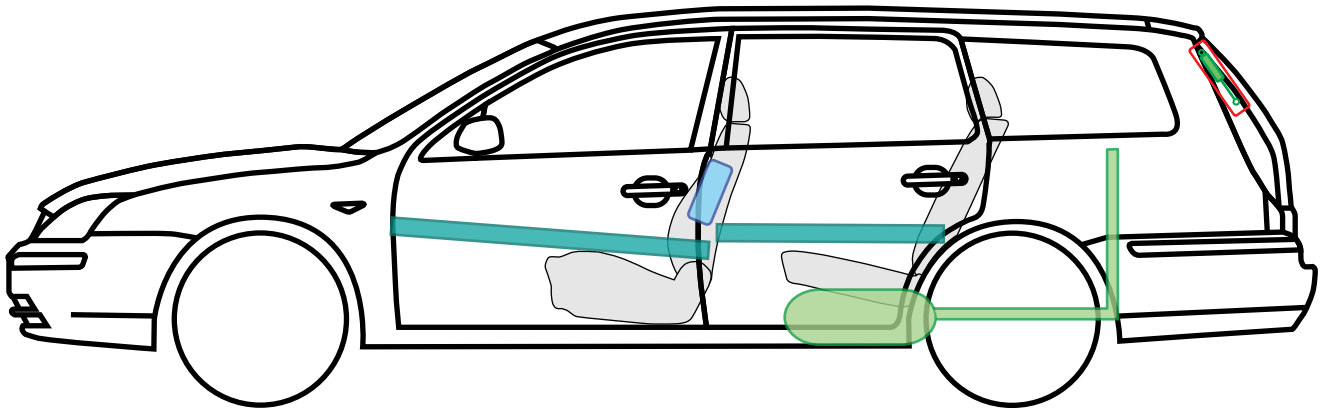
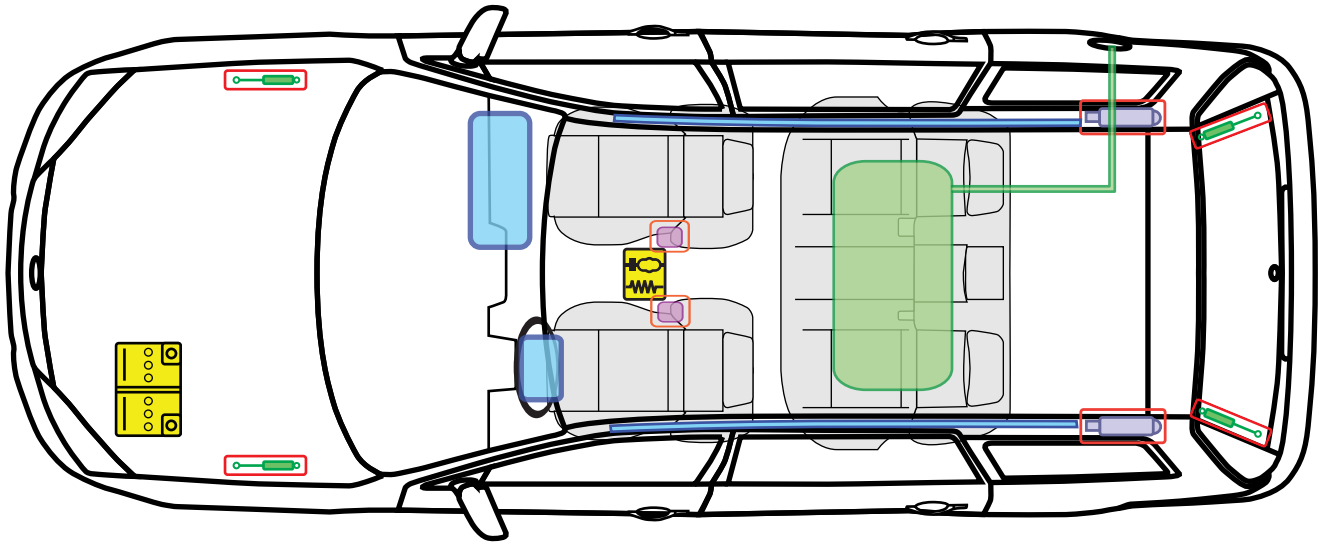

Legende

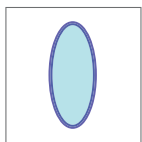

Airbag

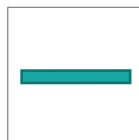

Karosserie-
verstärkung



Steuergerät

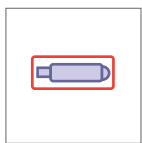

Gas-
generator

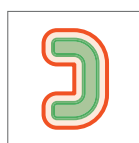

Überroll-
schutz

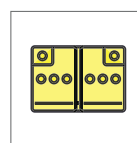

Batterie

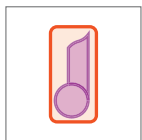

Gurt-
straffer

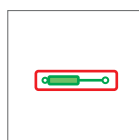

Gasdruck-
dämpfer

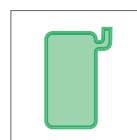

Kraftstoff-
tank





Ford Mondeo

4 Tüer

02/2007->

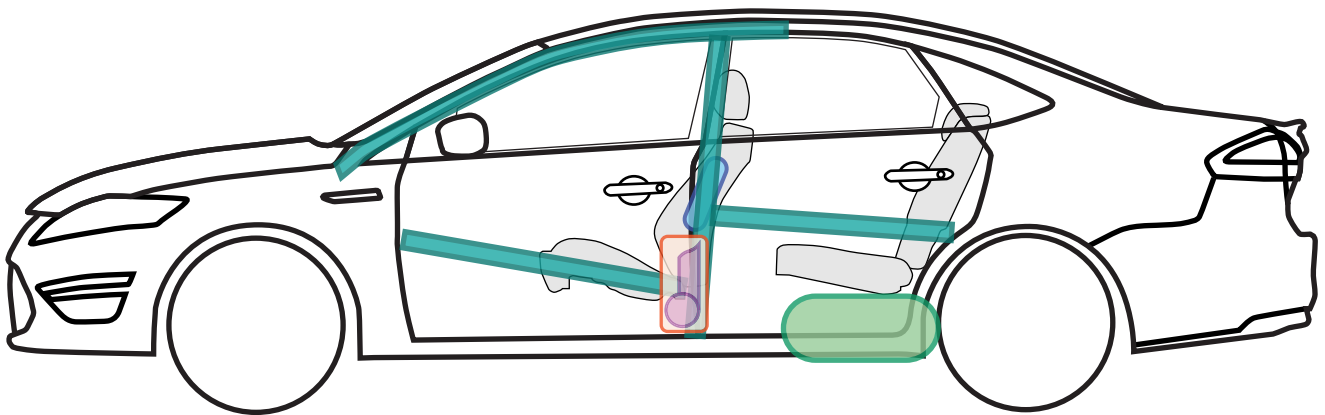
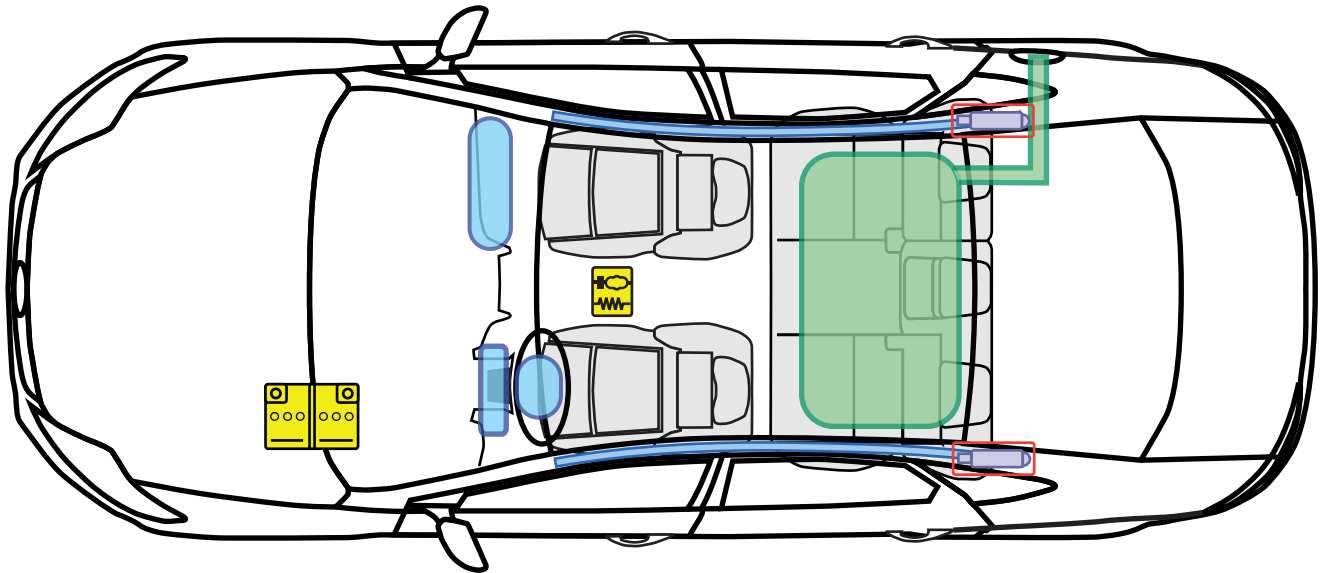

Legende

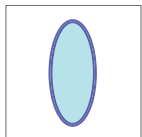

Airbag

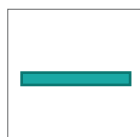

Karosserie-
verstärkung



Steuergerät



Gas-
generator



Überroll-
schutz

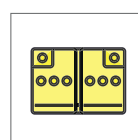

Batterie

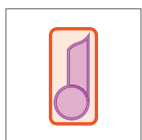

Gurt-
straffer

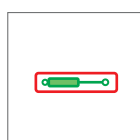

Gasdruck-
dämpfer

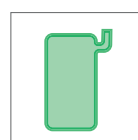

Kraftstoff-
tank





Ford Mondeo 4 Türer

02/2007->

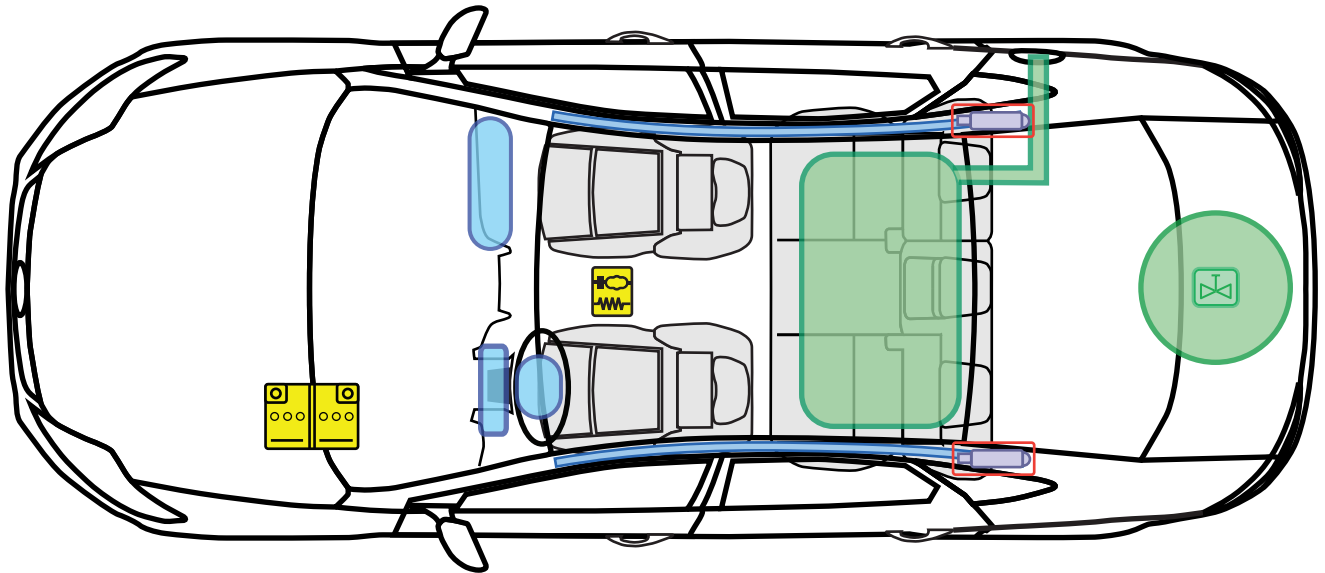

LPG

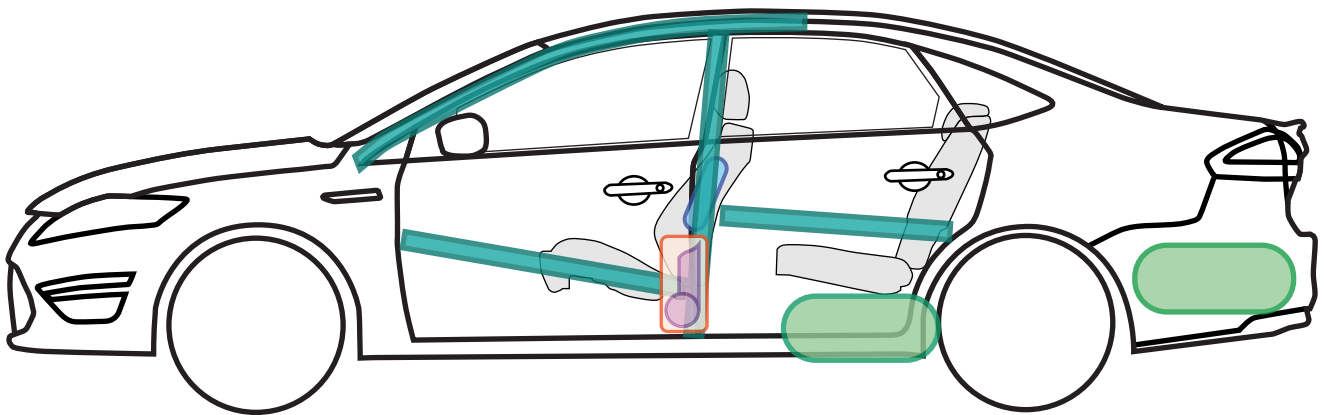

Legende

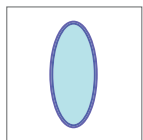

Airbag

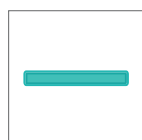

Karosserie-
verstärkung



Steuergerät



Gas-
generator



Überroll-
schutz

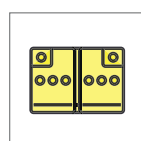

Batterie

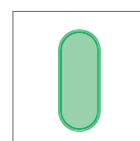

Gastank

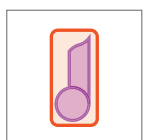

Gurt-
straffer



Gasdruck-
dämpfer

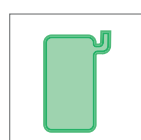

Kraftstoff-
tank

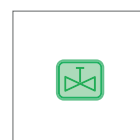

Sicherheits-
ventil





Ford Mondeo

5 Tüer

02/2007->

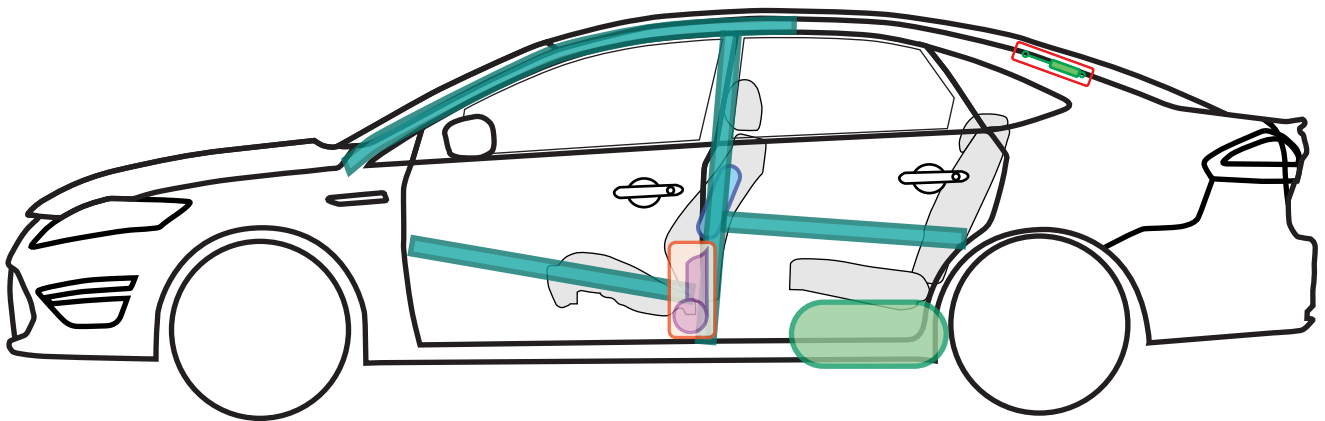
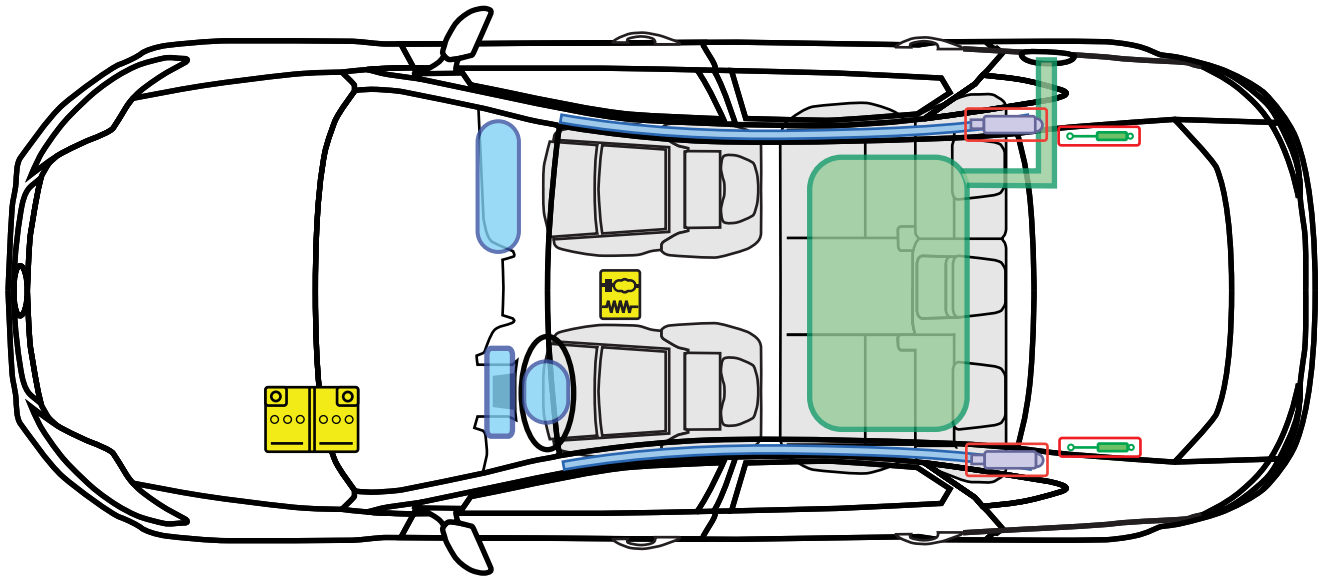

Legende

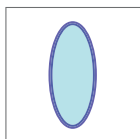

Airbag

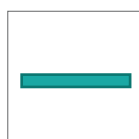

Karosserie-
verstärkung



Steuergerät

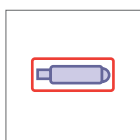

Gas-
generator



Überroll-
schutz

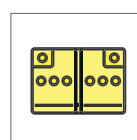

Batterie

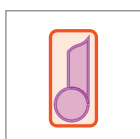

Gurt-
straffer

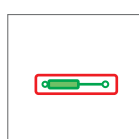

Gasdruck-
dämpfer

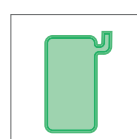

Kraftstoff-
tank





Ford Mondeo

5 Tüer

02/2007->

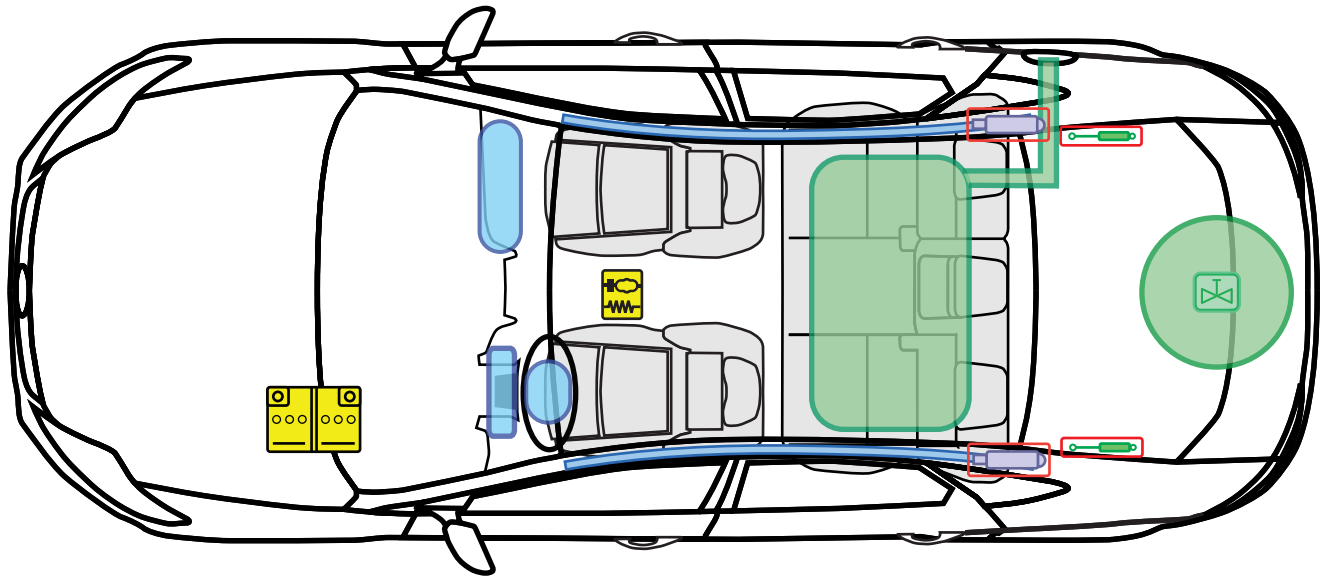

LPG

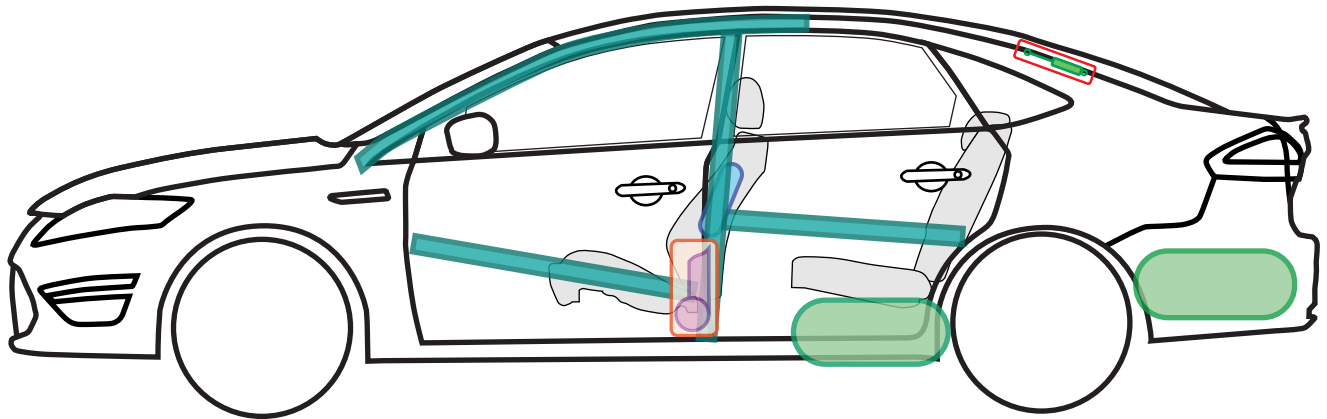

Legende

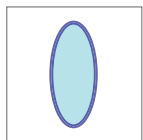

Airbag

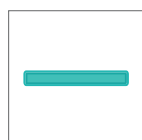

Karosserie-
verstärkung



Steuergerät



Gas-
generator



Überroll-
schutz

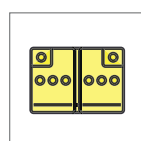

Batterie

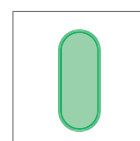

Gastank

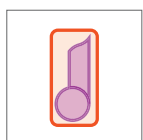

Gurt-
straffer



Gasdruck-
dämpfer

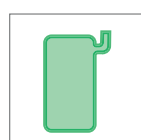

Kraftstoff-
tank

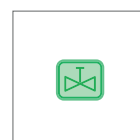

Sicherheits-
ventil



Ford Mondeo Turnier

02/2007->

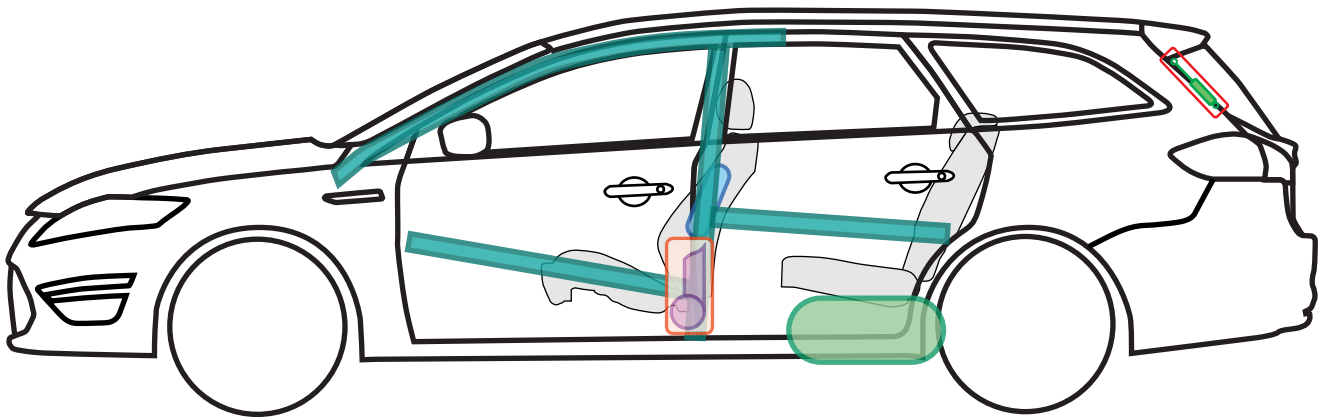
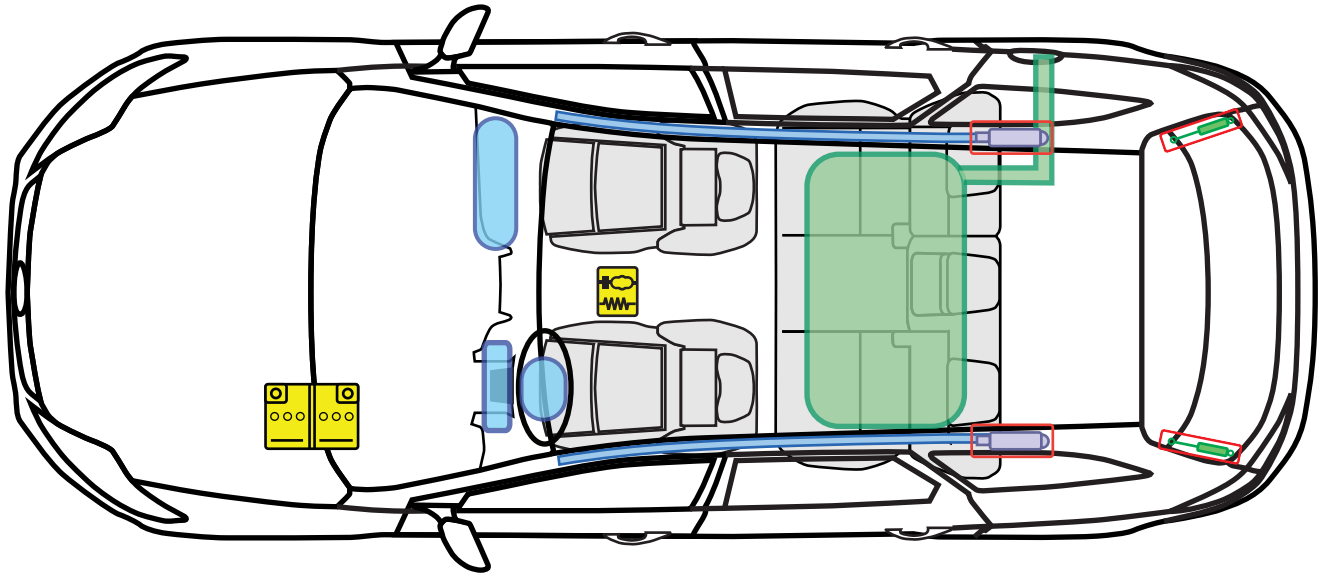

Legende

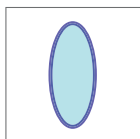

Airbag

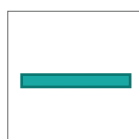

Karosserie-
verstärkung



Steuergerät

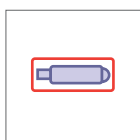

Gas-
generator



Überroll-
schutz

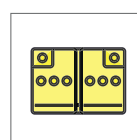

Batterie

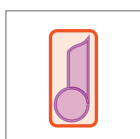

Gurt-
straffer

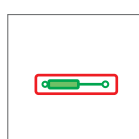

Gasdruck-
dämpfer



Kraftstoff-
tank





Ford Mondeo Turnier

02/2007->

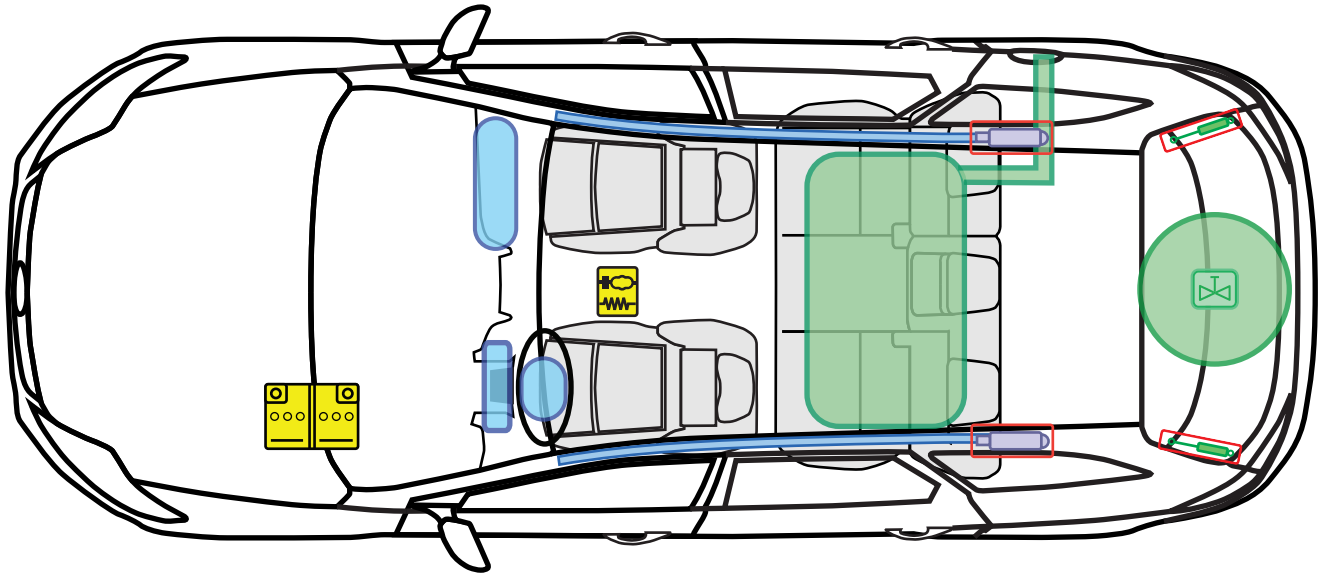

LPG

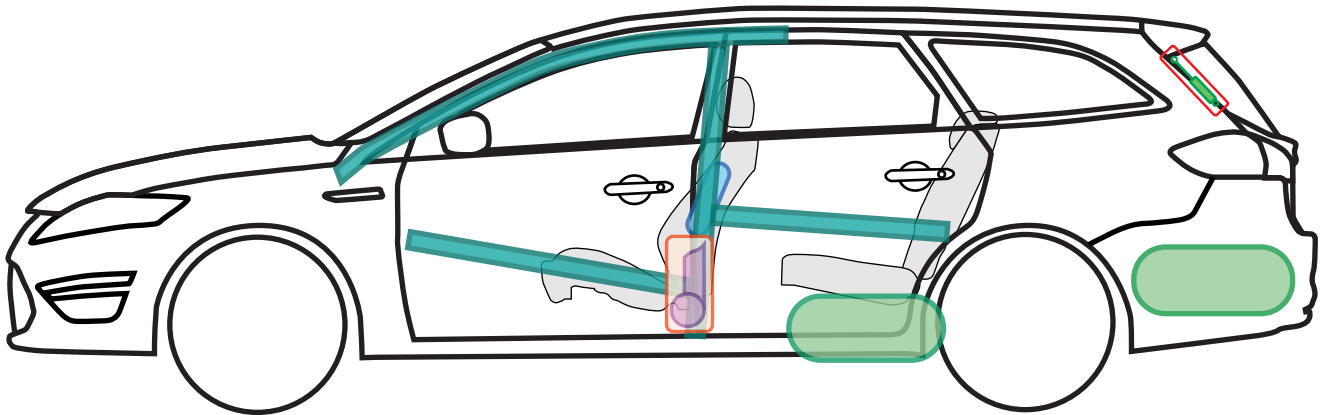

Legende

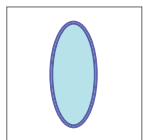

Airbag

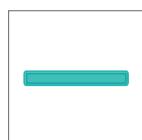

Karosserie-
verstärkung



Steuergerät



Gas-
generator



Überroll-
schutz

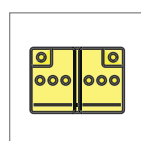

Batterie

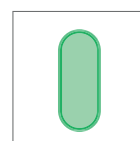

Gastank

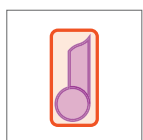

Gurt-
straffer



Gasdruck-
dämpfer

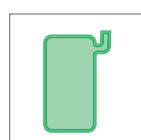

Kraftstoff-
tank

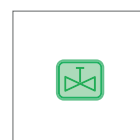

Sicherheits-
ventil

M



Ford S-MAX

02/2006->

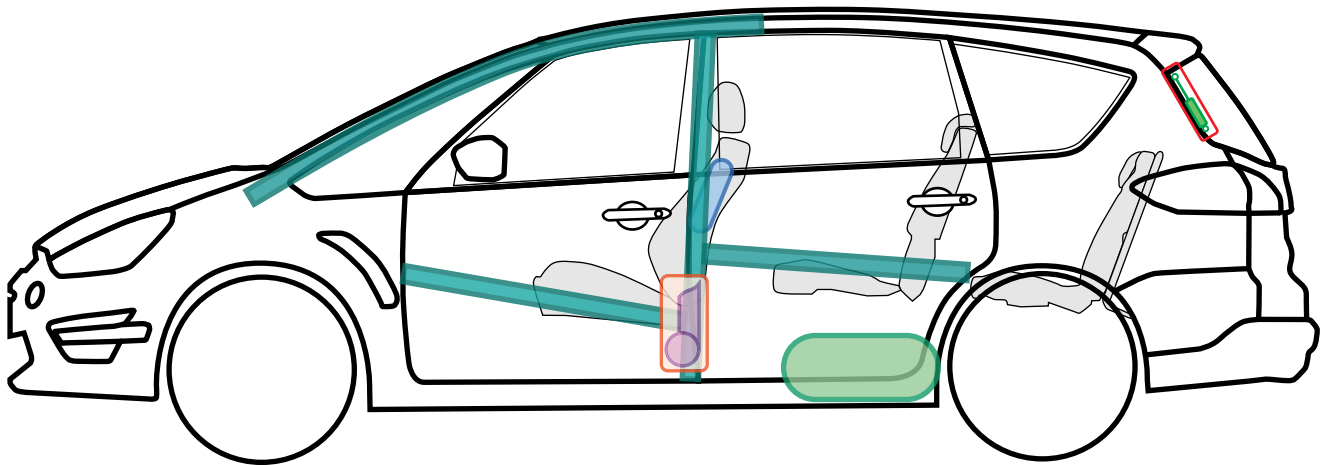
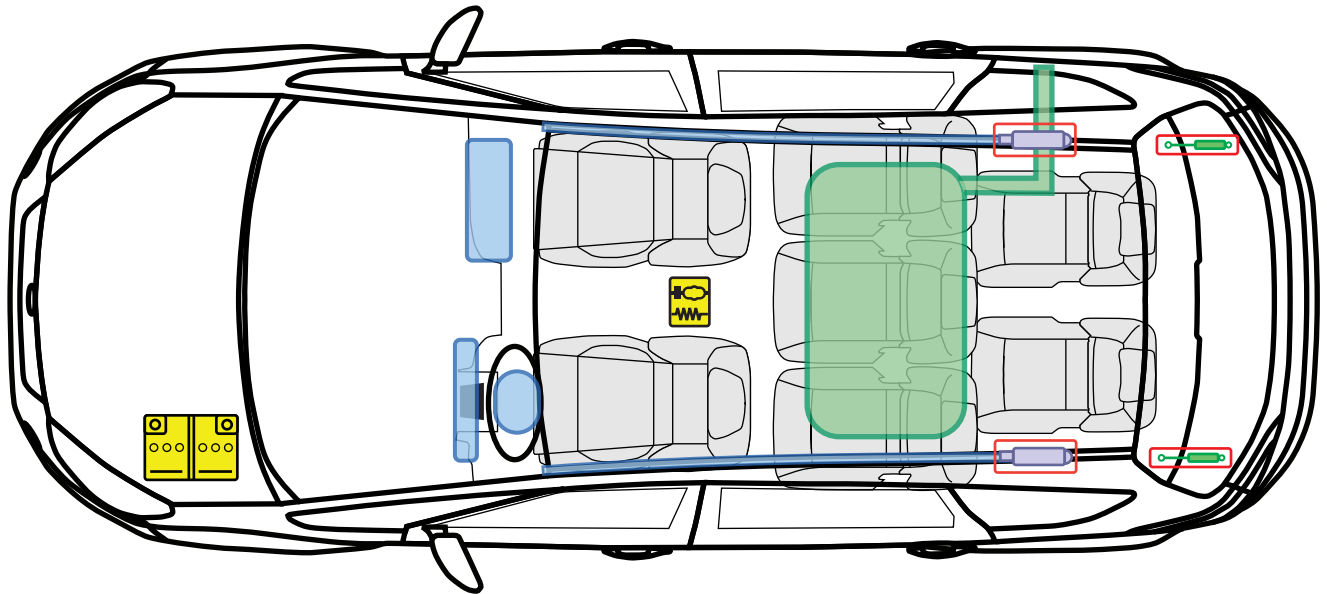

Legende

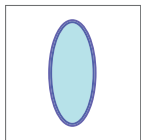

Airbag

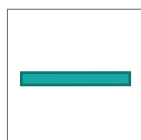

Karosserie-
verstärkung



Steuergerät

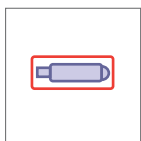

Gas-
generator

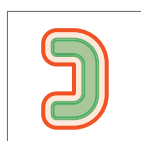

Überroll-
schutz

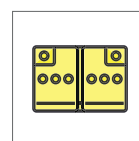

Batterie

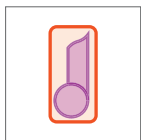

Gurt-
straffer

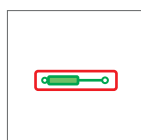

Gasdruck-
dämpfer

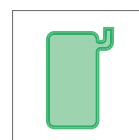

Kraftstoff-
tank

